

2022

EMAC MAGAZINE

EMAC® new trends at a glance

EMAC®
THE FINAL TOUCH

EMAC® GROUP | SPAIN | USA | ITALY |

#IT IS TREND

Architecture, Innovation
and Materials.

EMAC® EXCLUSIVE MATERIALS

ASTRA® an extra resistant polymer.

NOVOPELDAÑO ECLIPSE® AURA

So simple, so bright!

NOVOVIERTEAGUAS SP SYSTEM

In bad weather, put on a bright face.

NEW ON-LINE STORE

Only for distributors.

Novopeldaño Aura Eclipse®

new



EMAC®
THE FINAL TOUCH

EMAC® GROUP | SPAIN | USA | ITALY |

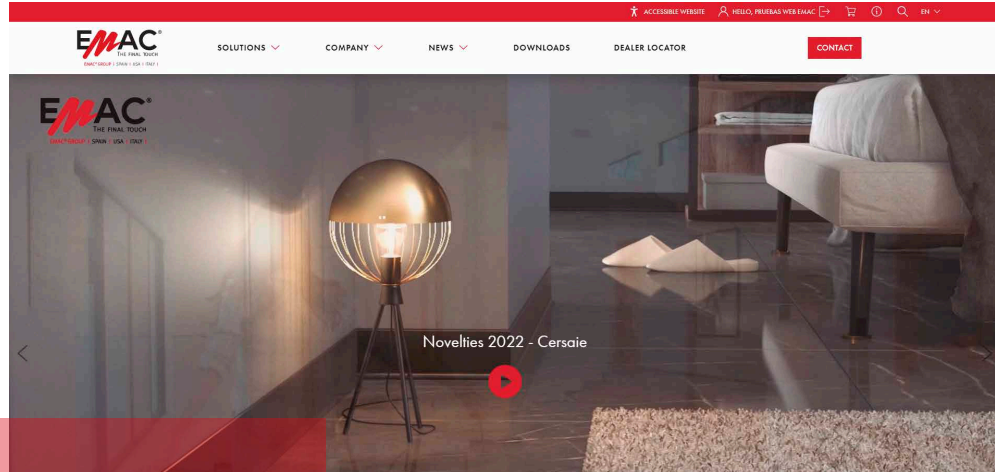

Digitalisation: how we are humanising our company

EMAC® Group has made innovation one of our foremost values as a company. Within this commitment to technology, digitalisation has become one of our recurring propositions in recent years with the goal of empowering interaction between the professionals in our team, our clients and our collaborators.

This digital process had be embraced if we were to compete in an increasingly competitive, global marketplace. So we have chosen gradually to improve and transform all protocols, models and processes.

At the heart of this evolution are data and people. Our team functions differently than it did before. We now constantly use digital tools such as mobile devices, social collaboration and corporate communication platforms, among other applications.

Among the latest advances that already form part of EMAC® Group's differential value we can highlight five lines of action:

New ERP: ERP is a critical piece of software that connects and enhances many day-to-day tasks such as inventory management, ordering, supply chain, finance, human resources, purchasing, project management, marketing and customer service. In a company where 95% of incoming orders are served on the same day, this tool is indispensable.

EMAC® App: a useful and effective augmented reality tool to select and recommend our structural joint system in the app's memory. A simple solution that lets you discover models, finishes and performance, along with the best option for combining structural joints, Novomembrana EPDM sealing membrane and fireproof cord on each project. Essential for architects, planners and site managers.

New website: Our portal www.emac.es has been improved during 2021 to offer Internet users more options, additional tools and a new architecture. Along with a fresh image, greater security and faster speed, it

EMAC® Group has made innovation one of our foremost values as a company.

provides up-to-date technical information on our entire product range. This is complemented by compiling social and sales activity.

New web usability and accessibility tool: One of EMAC® Group's premises is the search for universal accessibility in the field of construction. And this maxim extends to the digital world. Thus, as a result of ongoing collaboration with the ONCE Foundation and the Valencian company Insuit, we have added a tool kit to our website.

This kit aims to enable browsing for people with little or no vision, mobility, speech difficulties, cognitive or intellectual difficulties. It furthermore seeks to make things easier for the elderly, people with reading difficulties, or those with few digital skills to visit our website.

New online store: Our company has gone one step further in its digitalisation project. We now have an exclusive gift shop for distributors specialising in building materials. This is an exclusive, private space where you can purchase or obtain a free quote for our more-than 5,000 references. Available in four languages, our store is designed to optimise operation in just a few clicks. It is connected directly to our ERP and therefore to our stock. So it compiles all technical information and all the various aesthetic possibilities at the time of purchase.

EMAC® Group thus concludes a year of success in sales and digital transformation as a result of putting people at the heart of our strategy.

INDEX

TRENDS
EMAC[®]
THE FINAL TOUCH
2022

www.emac.es/en



NOVELTIES AND DIGITALIZATION	2
01. EXCLUSIVE MATERIALS	4
02. DECORATIVE SOLUTIONS	11
03. OUTDOOR SOLUTIONS	20
04. SANITARY AND HEALTH ESTABLISHMENT	22
05. ASU SOLUTIONS	24
06. TECHNICAL SOLUTIONS	27

EMAC[®]
THE FINAL TOUCH
EMAC GROUP | SPAIN | USA | ITALY

TRENDS
EMAC[®]
 THE FINAL TOUCH
2022

EXCLUSIVE MATERIALS

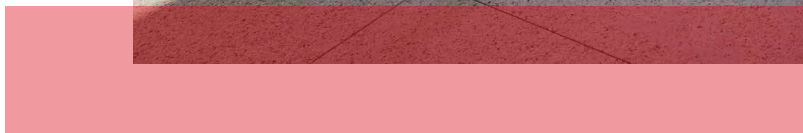
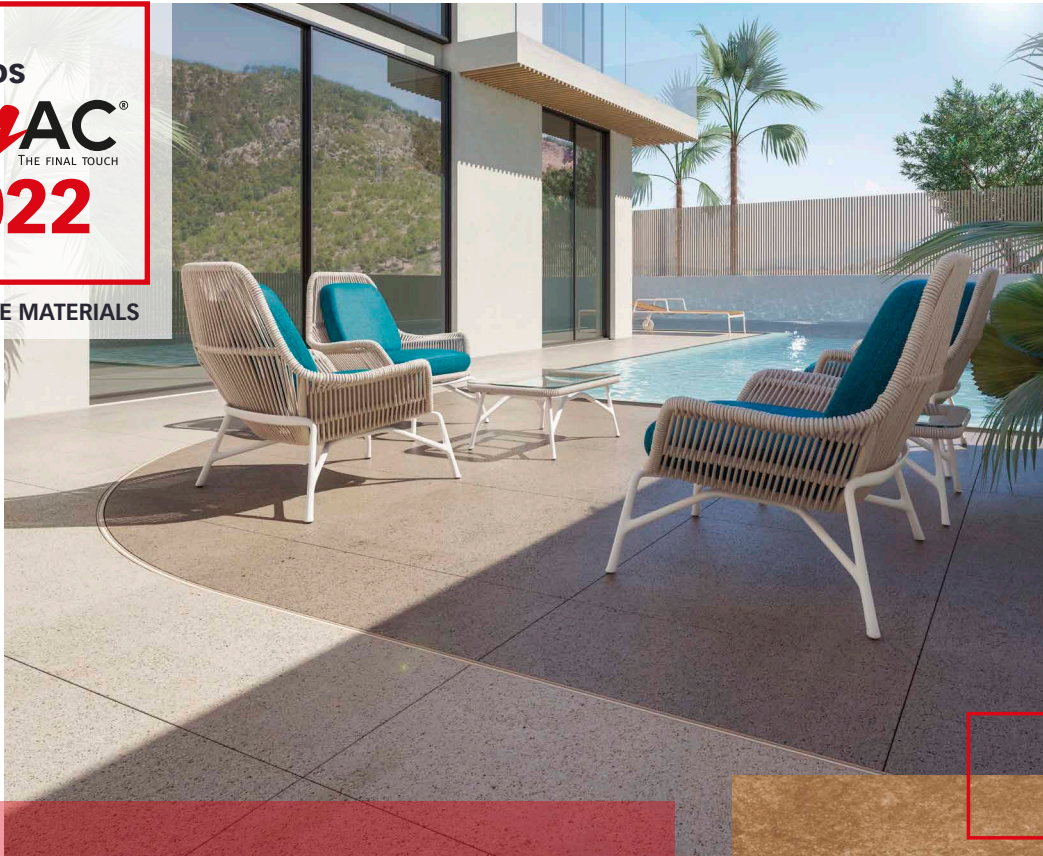

Novojunta ASTRA[®]

Profile for expansion joints made of our exclusive material **ASTRA[®]**, an extra resistant polymer and a central flexible body made of EPDM. It is an ideal solution for exteriors with the possibility of bending, which multiplies its installation possibilities. The different combinations of colors of **Novojunta ASTRA[®]**, fit with the latest trends and make it suitable to be installed in any environment. Available in five colours in line with the most commonly used ceramic shades on the market.

Novojunta ASTRA[®] absorbs the movements of the flooring, helping to prevent cracks and damage without losing sight of its integration into the ceramic system thanks to its trendy colors.

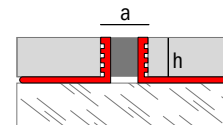

a: 9 mm.
 h: 10/12 mm.
 length: 2,5 m.



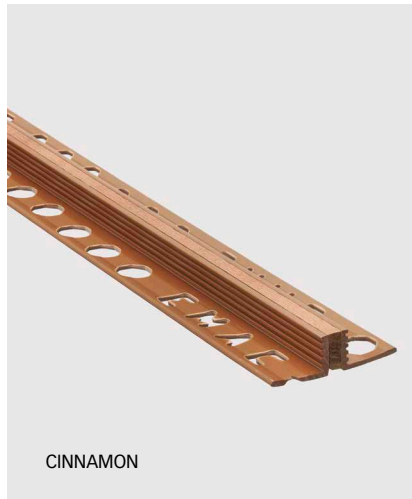
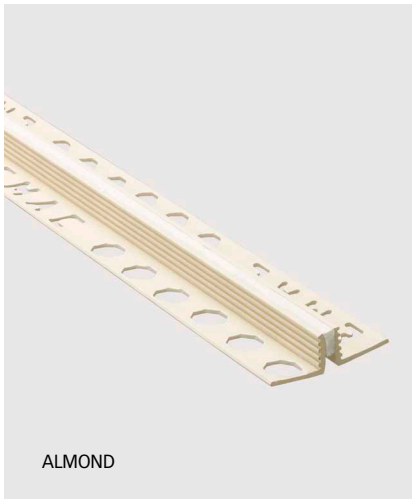

The colors in the range are stable and long-lasting in exterior thanks to the studied dosage of dyes of maximum solidity that preserve their appearance with the pass of the time.

Novojunta ASTRA®



TRENDS
EMAC[®]
 THE FINAL TOUCH
2022

EXCLUSIVE MATERIALS



Novopeldaño ASTRA[®] Nori

Novopeldaño ASTRA[®] Nori is a stair nosing profile made of the exclusive ASTRA[®] material, an extra resistant polymer specially developed to obtain the best benefits in all kind of environments. Not only indoors but also in submerged or humid environments or outdoors. Thanks to the addition of biocides, which prevent from mold growing, it stands stable in humid and submerged environments.

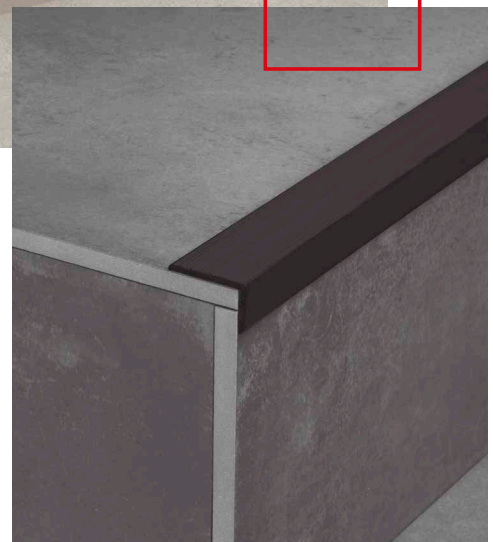

14441-14442

Subjected to slippery tests according to UNE41901:2017 EX y DIN51130.



This material has a great impact resistance, improved in the formulation with several additives and a perfect balance of mineral reinforcer, which allows its use infloorings with guarantees. The colors available are stable and durable, thanks to the studied dosage of maximum solidity dyes, preserving its appearance along the time.

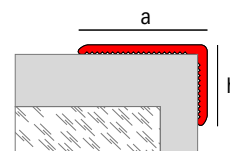

a: 40 mm.
 h: 25 mm.
 length: 2,5 m.

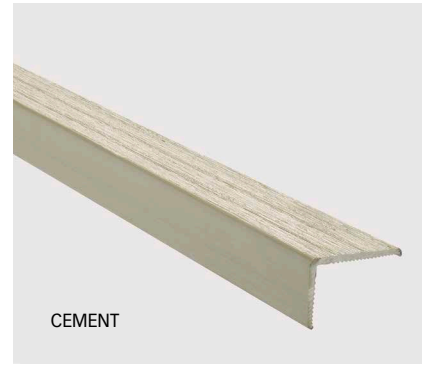
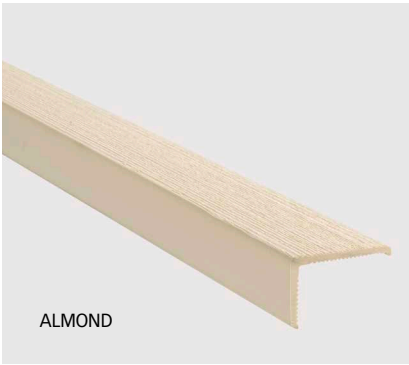

This stair nosing profile is to be installed after the tiling work with adhesive or screws, being the perfect option for new projects or rehabilitation and reform works. Available in five colors that can integrate with the most

trendy finishes in floorings in the markets or make a contrast with them. We have added the new colours of ash and almond to the existing range of black, cinnamon and cement.

ASTRA® Nori

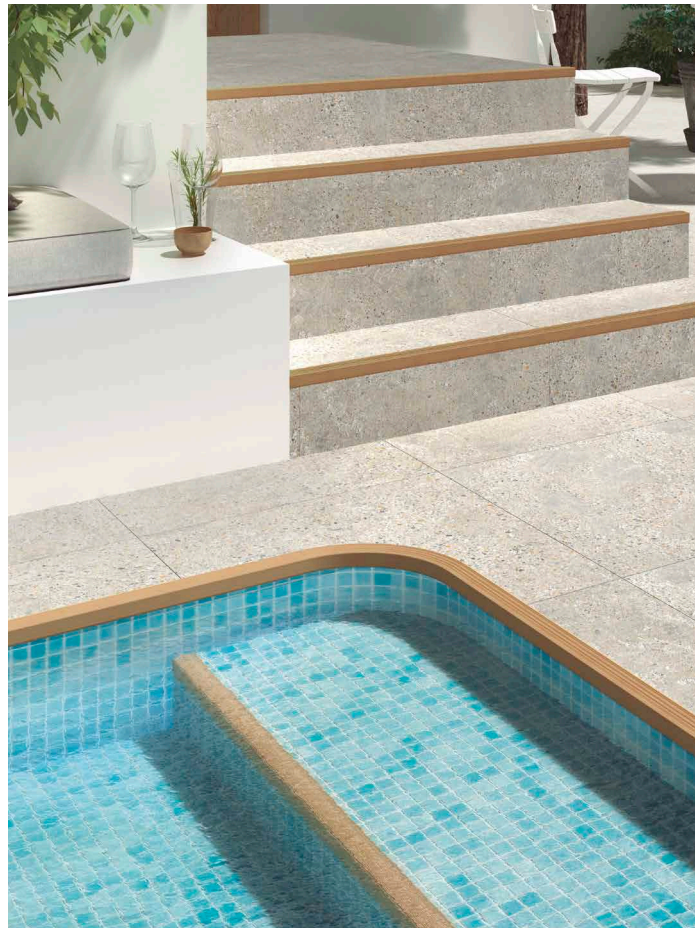
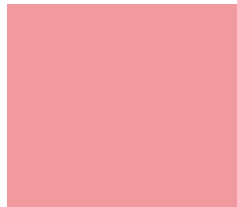

TRENDS
EMAC[®]
 THE FINAL TOUCH
2022

EXCLUSIVE MATERIALS

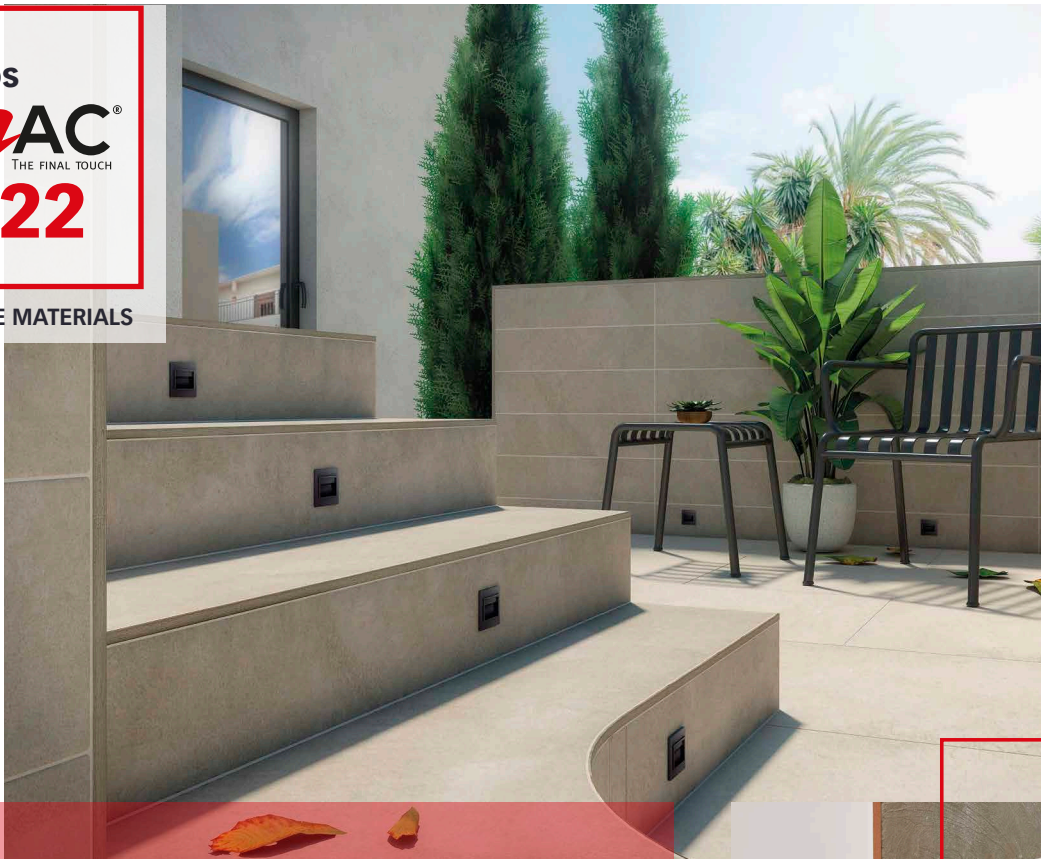

Novosuelo ASTRA[®] Kombu

New ash color for this profile of straight lines manufactured in **EMAC**[®]'s exclusive material: **ASTRA**[®]— an extra-tough polymer. This is a multi-purpose profile, and can be installed as a finish to protect and decorate the borders of ceramic cladding, as a paving separator, or as a counter top finish. And it offers an innovative grooved finish, giving it a rustic aesthetic and improving performance in bad weather.

The profile is installed during the tiling work and is integrated into the cladding. Furthermore, the material offers excellent resistance to impact, meaning it can reliably be used as a profile in paving and borders. It comes in five colours that are stable and long-lasting outdoors.

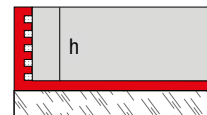
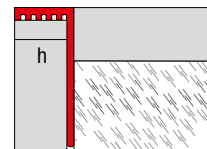

h: 10/12 mm.
 length: 2,5 m.



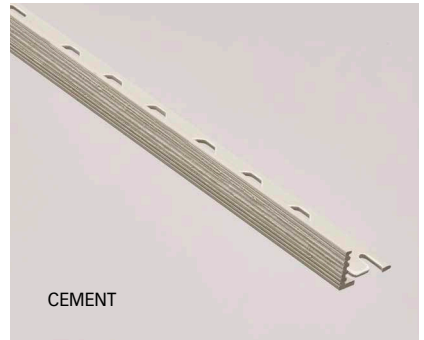

ASTRA® KOMBU

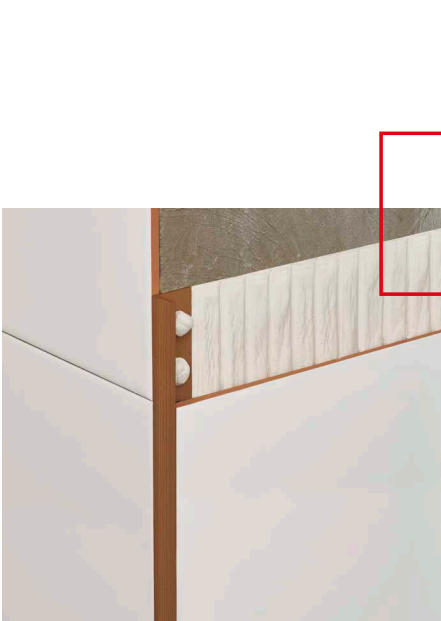



TRENDS
EMAC[®]
THE FINAL TOUCH
2022

www.emac.es/en

DECORATIVE SOLUTIONS



NOVOPELDAÑO ECLIPSE [®] AURA	12
NOVORODAPIÉ [®] L	14
NOVORODAPIÉ ECLIPSE [®] SP	16
NOVOSEPARA [®] 4	17
NOVOLISTEL [®] 3	18
NOVOLISTEL [®] 3XS	19

TRENDS
EMAC[®]
 THE FINAL TOUCH
2022

DECORATIVE SOLUTIONS



Novopeldaño Eclipse[®] Aura

In 2022, our family will expand further with a new concept in steps which, in line with current trends, offers unique indirect lighting in a step that is integrated into the building without a visible step.

Its **minimalist design** is married to its functional character, as it fulfills its main function of protecting the pavement edges. It is a trend-setting solution. This is why for the first time it is also available in a matt-silver or matt-black finish. Available in 10- and 12-mm heights, with a protective film on the exposed face and end caps to give the installation a perfect finish.

Industrial design
 European
 Community and
 International

- DI0085873272
- DM215977
- DI202102261

Novopeldaño Eclipse[®] Aura, so simple, so bright.

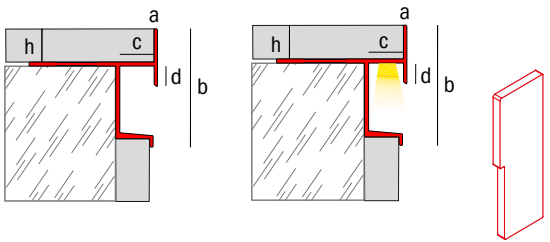

a: 1mm. | b: 35,5/37,5 mm.
 c: 10,3 mm. | d: 6,1 mm. | h: 10/12 mm.
 length: 2,5 m.



*** NOTICE**

Promotional atmosphere showing a suggestion for one possible use of this product. EMAC[®] does not manufacture, sell or supply any LED strip whatsoever. The choice of LED strip should be undertaken by the installer, taking into account the circumstances of the installation site.

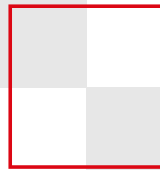
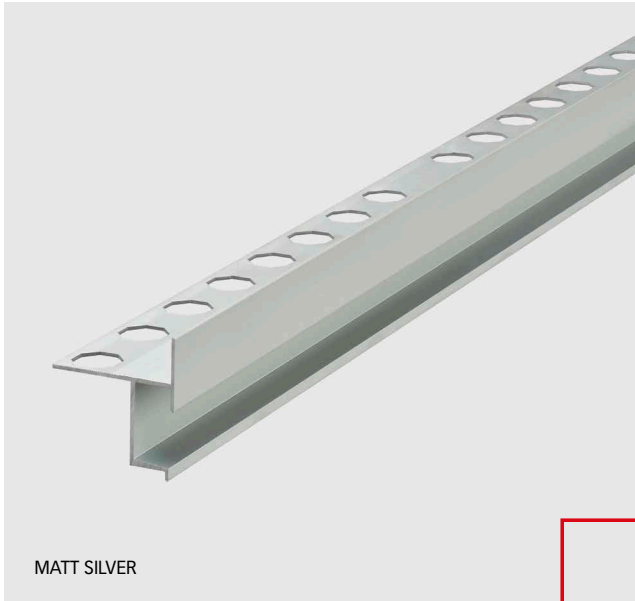

Novopeldaño
Eclipse® Aura



TRENDS
EMAC[®]
THE FINAL TOUCH
2022

DECORATIVE SOLUTIONS



Novorodapié[®] L

Novorodapié[®] L is a smart profile with simple design, made of anodized or lacquered aluminum and intended to be installed as a skirting in all kind of walls. Its geometry, which ends with a smooth curve, makes easier the cleaning and avoids the accumulation of germ. It is also useful to cover the typical expansion joints in perimeters.

This profile is very easy to install. It is perfect for new or reform works and in projects where a big quantity of meters is needed.

Available in three different heights and 2,5 m length.

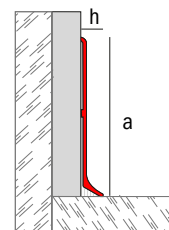
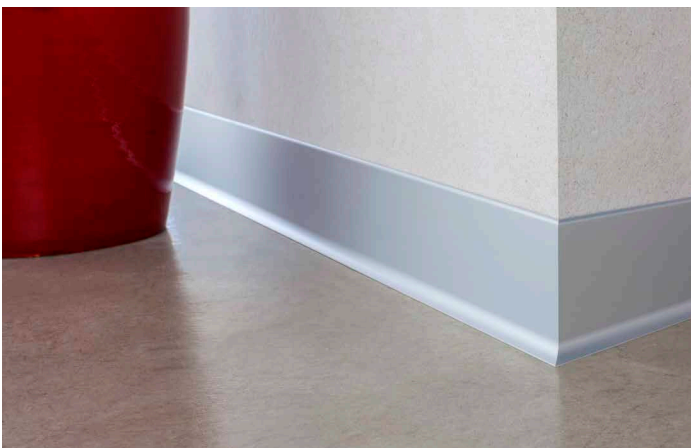

a: 60/80/100 mm.
h: 10,7/10,7/18 mm.
length: 2,5 m.

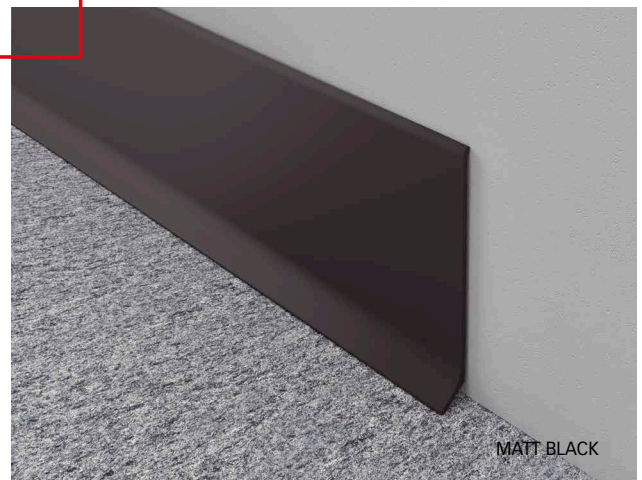
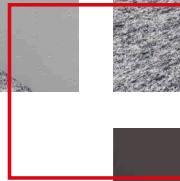

Novorodapié® L

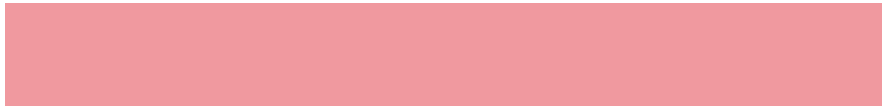

Now, this skirting is available in the trendiest finish, matt black.





DECORATIVE SOLUTIONS

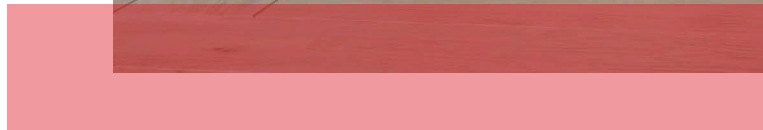

Novorodapié Eclipse® SP

Novorodapié Eclipse® SP is made of aluminum profile designed to be installed as a skirting board in installations with all kinds of coatings. Its geometry with straight lines and smooth surface protects the cladding and allows it to be installed before or after work, covering the perimeter joint. This profile is highly versatile and reversible. It can be placed, in addition to a skirting board, as an intermediate or upper finish on the wall in two different positions.

Utility Model

MU202031050

Community Design

DI8454763

MATT WHITE

Optionally, an LED strip (not included) can be installed in any of the interior hollows, being able to choose between

a more discreet or more visible lighting. A strip of the same coating can also be placed in the larger hole, obtaining a finish that is fully integrated into the installation.

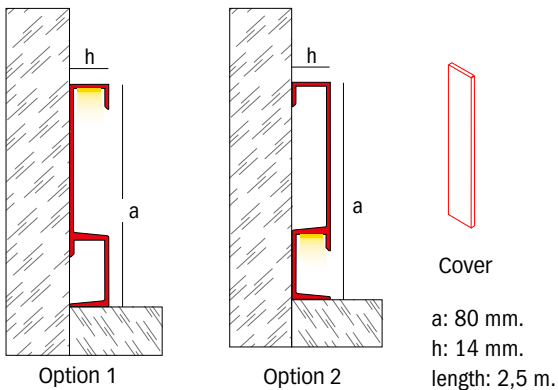

*NOTICE

Promotional atmosphere showing a suggestion for one possible use of this product. EMAC® does not manufacture, sell or supply any LED strip whatsoever. The choice of LED strip should be undertaken by the installer, taking into account the circumstances of the installation site.

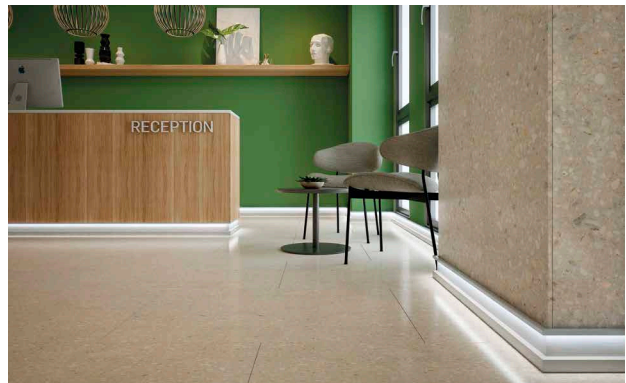

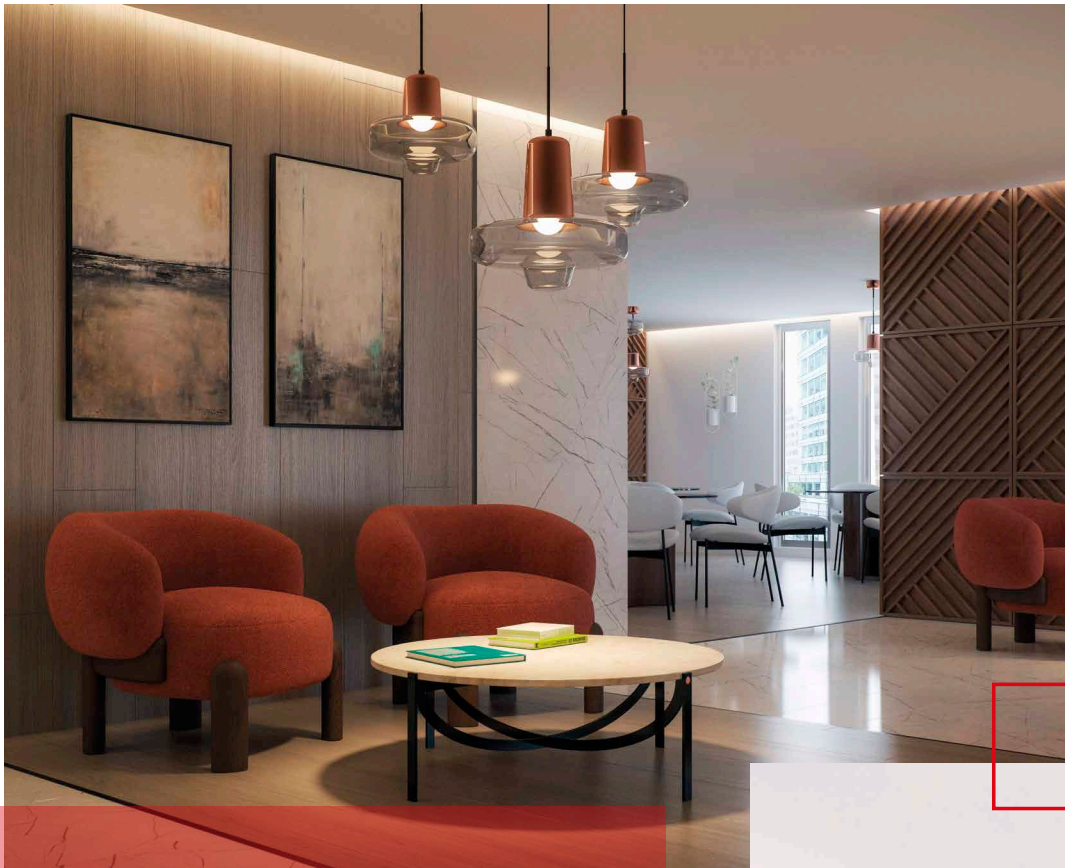

Novosepara® 4

Embellisher profile for joints. The top section covers and decorates the joint created by tiles. For its placement, just incrust it into the joint between floorings. It can be placed before or after the flooring.

Its 7-mm leg makes it highly versatile. It can be used on different thicknesses and types of flooring. Its 15-mm visible face makes it highly attractive for the latest "fine line" styles. Along with its latest matt black finish, this makes it perfect for creating highly decorative environments, not only on the floor, but also on the wall, even achieving continuity between horizontal and vertical planes.

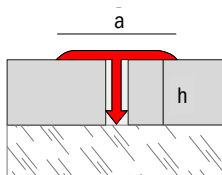

a: 15 mm. | h: 7 mm.
length: 2,5 m.



TRENDS
EMAC[®]
THE FINAL TOUCH
2022

DECORATIVE SOLUTIONS

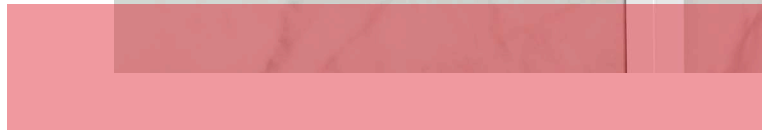

Novolistel[®] 3

One of the classics, the original EMAC[®] profile that revolutionised the market with its versatility, known worldwide as the seven-in-one profile.

Made of aluminium and available in more than 20 finishes for protecting and decorating ceramics, this adds a trend-setting new finish to our range.

A pure white finish that joins our existing antibacterial matt-white finish for installations with stricter hygienic or sanitary requirements. Both finishes come with matching accessories.

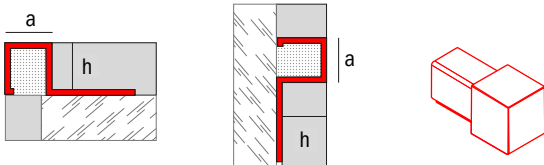

a: 10 mm. | h: 10/12 mm.
 length: 2,5 m.

Corner





Novolistel® 3XS



Novolistel® 3XS

Novolistel® 3 XS in Matt Gold and Bright Gold. This decorative aluminium profile, characterised by its slim, discreet visible face (6.4 mm), is aligned with the latest trends towards lighter lines. We have now extended this range to include the Matt Gold and Bright Gold finishes, available on faucets, lamps and other decorative elements.

We can highlight the wide versatility of its various uses, providing any environment with a finishing touch that is simple yet elegant. Available in natural aluminium and anodised matt silver.

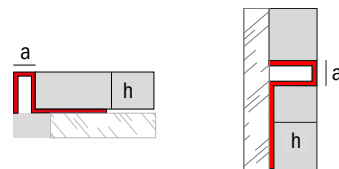

a: 6,4 mm. | h: 10/12 mm.
length: 2,5 m.

TRENDS
EMAC[®]
 THE FINAL TOUCH
2022

OUTDOOR SOLUTIONS



Novovierteaguas SP System

An overlay guttering system to be installed on roofing, terraces, balconies and/or windows before or after works. The system's main piece is a lacquered aluminium profile grooved along its entire length with an exclusive EMAC[®] throating, which increases the effectiveness of its main function: channelling water away from the wall, thereby avoiding streams of rainwater down the façade.

Utility Model

MU202032671

Community Design

DI008317960

It has a double means of waterproofing to avoid water filtering through the profile. Underneath, the profile contains a cavity where an LED strip may optionally be

installed, enhancing its decorative effect. The system's functionality is completed with finishing accessories such as angles, coverings and joints.

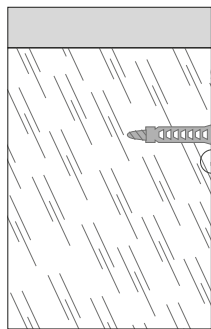

Novovierteaguas SP System

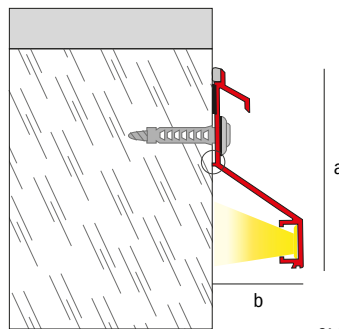

Novovierteaguas SP System with LED (optional)

a: 62 mm.
 b: 28 mm.
 length: 2,5 m.

Complementary Pieces

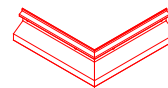

Outer Angle

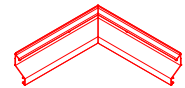

Inner Angle



Cover

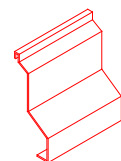

Union piece

* ADVERTENCIA INFORMATIVA

Promotional atmosphere showing a suggestion for one possible use of this product. EMAC[®] does not manufacture, sell or supply any LED strip whatsoever. The choice of LED strip should be undertaken by the installer, taking into account the circumstances of the installation site.



Novovierteaguas SP System

A new corner piece, finished and ready to install with our **Novovierteaguas SP System**.



NOVOVIERTEAGUAS SP SYSTEM

Double Waterproofing System.

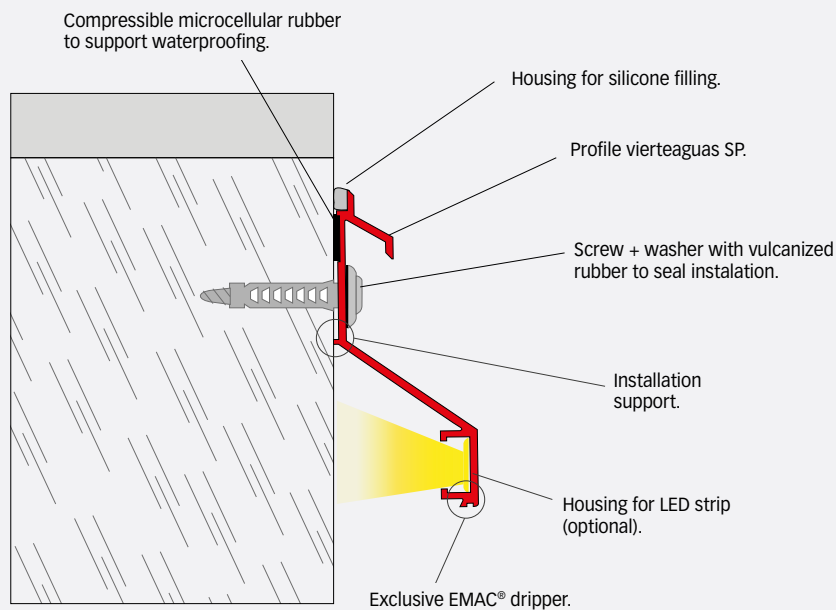

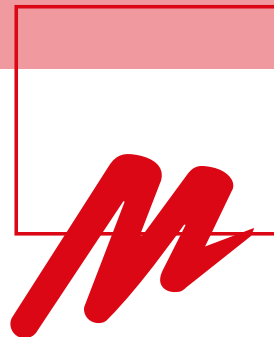

Novoescocia 4 PVC

Novoescocia® 4 PVC is a cove-shaped profile made of white PVC extrusion. This solution avoids build-up of germs and dirt in the meeting points between wall-floor-ceiling, facilitating the cleaning.

It is slightly flexible to adapt to the irregularities of any wall or floor. It is ideal for being installed in areas as industrial kitchens, refrigerators, dressing rooms...

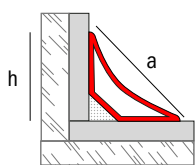
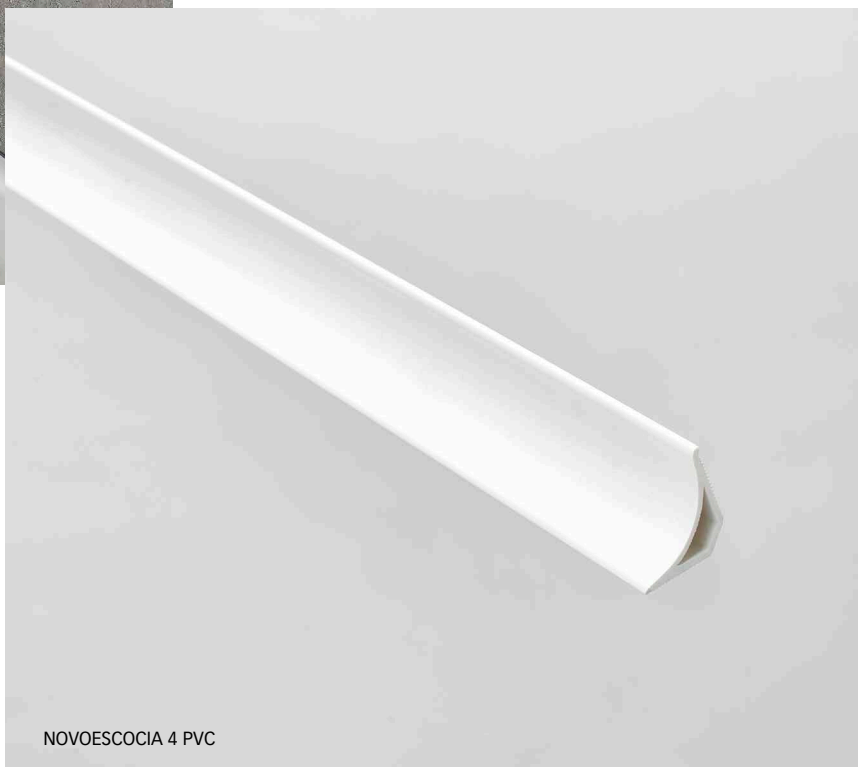

a: 20/36,5 mm. | h: 25 mm.
length: 2,5 m.

NOVOESCOCIA 4 PVC



Gabarits pour Accessibilité et Sécurité Universelle

New Templates for Universal Accessibility and Safety: In response to demand, the launch of the ASU Accessibility Challenge in 2019, in collaboration with Fundación ONCE®, was a huge success. Along with the constant appearance of new regulations and recommendations concerning accessibility, this means more and more facilities require Universal Accessibility and Safety Systems to be installed.

To facilitate installation, two new larger models have been added to the existing templates, allowing for much faster, more efficient installation in accordance with CTE guidelines. These are 40-cm-wide routing strips, parallel button rosettes at changes of direction, and 80-cm-wide signposting sections at the start of stairs or ramps running parallel to the stairs.

Installation XL Templates

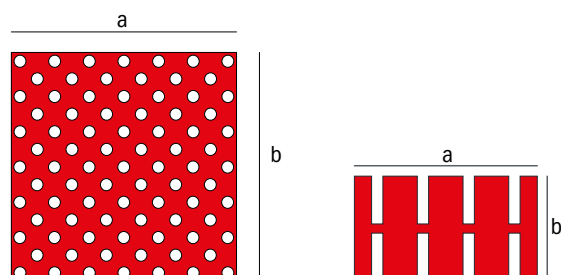

a: 487,5 mm
b: 487,5 mm

a: 492 mm
b: 285 mm



TRENDS
EMAC[®]
THE FINAL TOUCH
2022

www.emac.es/en

TECHNICAL SOLUTIONS



NOVOJUNTA [®] PRO BASIC RS	28
NOVOJUNTA [®] PRO BASIC SP	29
NOVOJUNTA [®] PRO BASIC SLIMM	30

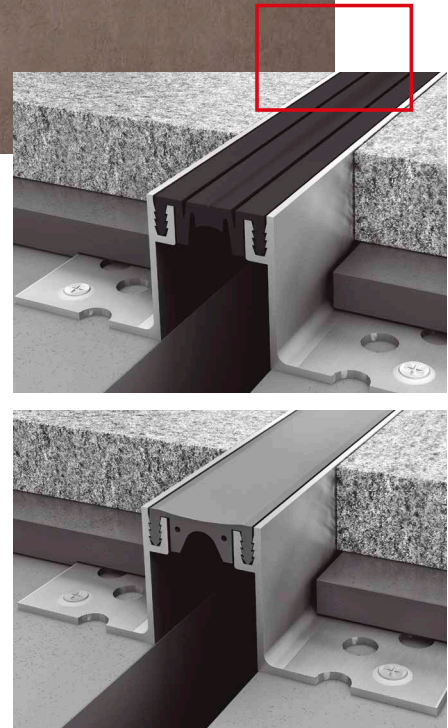

Novojunta[®] Pro Basic RS

Novojunta Pro[®] Basic is a system of profiles intended to be installed in expansion joints up to 40 mm width. It consists of two aluminum profiles holed on the base for the fixing screws with an EPDM rubber insert that absorbs multidirectional movements.

This range is highly functional since both aluminum and rubber profiles can be combined. So if we have an expansion joint between two slabs of different height, we can purchase different pieces according to our needs. The EPDM resists weathering, thermal changes, wear and moisture.

The flat finishes are the most appropriate choice for places with high hygienic requirements like hospitals. Available in black or grey colour, with flat or striated finish.

New length of 2.5 m and immediate availability allow minimum delivery times.

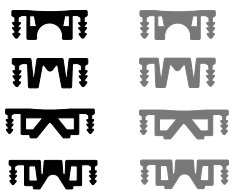

EPDM Rubbers

Type: Flat o striated
 Colour: black or grey.

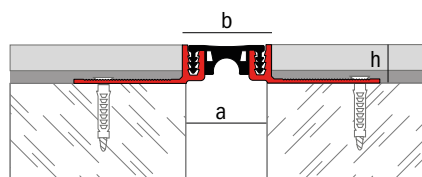

a: 20, 30 y 40 mm. | b: 24, 34 y 44 mm.
 h: 14, 22, 40, 50 y 80 mm. | length: 2,5 m.

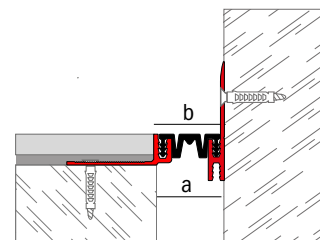

a: 20, 30 y 40 mm. | b: 24, 34 y 44 mm.
 h: 22,5, 32,5 y 42,5 mm | length: 2,5 m.



Novojunta® Pro Basic SP

Novojunta Pro® Basic SP is a profile for expansion joints up to 40 mm width to be installed in overlaid joints (after finishing work).

Consists of two aluminum profiles, height 11 mm, drilled for its fixing with screws. The EPDM resists weathering, thermal changes, wear and moisture and it is delivered with two different finishes. Available in black or grey color with flat or striated finish.

New length of 2.5 m and immediate availability allow minimum delivery times.

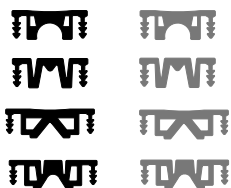

EPDM Rubbers
Type: Flat o striated
Colour: black or grey.

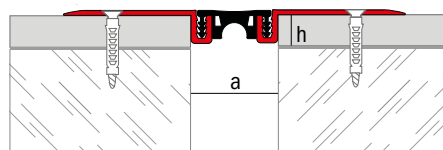

a: 24, 34 y 44 mm. | h: 11 mm.
length: 2,5 m.

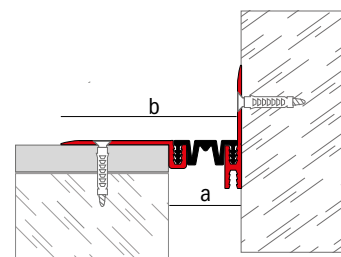

a: 24, 34 y 44 mm. | b: 72, 82 y 92 mm.
length: 2,5 m.

TRENDS
EMAC[®]
 THE FINAL TOUCH
2022

TECHNICAL SOLUTIONS



Novojunta[®] Pro Basic SlIMM

Novojunta Pro[®] Basic SlIMM is a system of profiles up to 40 mm width suited to be installed in low ceramic thickness like vinyl flooring or carpets among others.

This solution consists of two aluminium profiles with holes for the fixing screws and a central part made of high quality EPDM rubber that it is inserted into the aluminum profiles.

Available in two different finishes (flat and striated) and colors (black and grey).

New length of 2.5 m and immediate availability allow minimum delivery times.

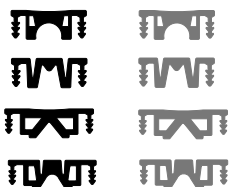

EPDM Rubbers
 Type: Flat o striated
 Colour: black or grey.

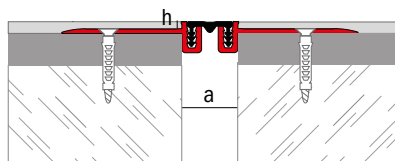

a: 24, 34 y 44 mm. | h: 3 mm.
 length: 2,5 m.

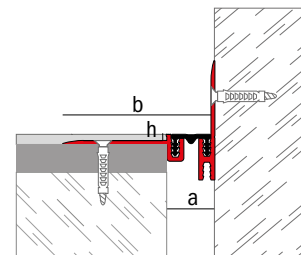

a: 24, 34 y 44 mm. | b: 72, 82 y 92 mm.
 length: 2,5 m.

5% Discount when buying ON-LINE until January 31st , 2022



NEW ON-LINE STORE! *



Enter to Buy

*Only for Distributors

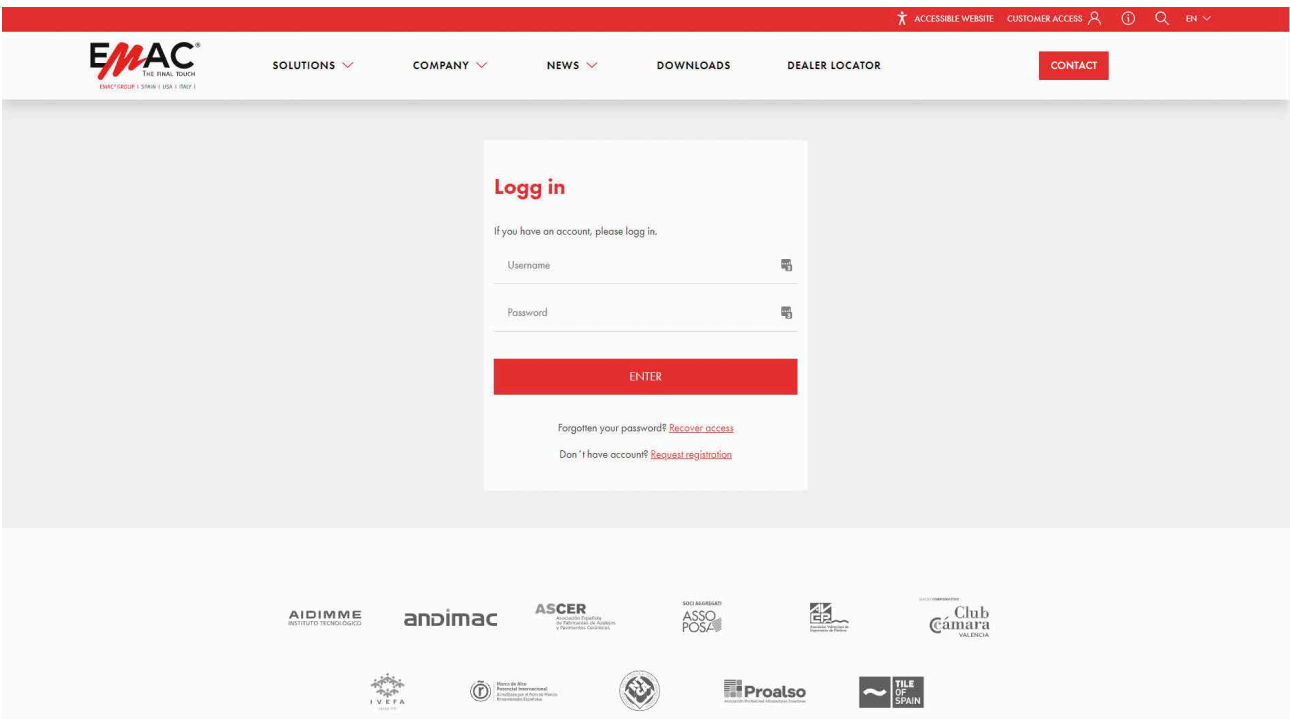

ACCESSIBLE WEBSITE CUSTOMER ACCESS

EMAC
THE FINAL TOUCH
EMAC® GROUP | SPAIN | USA | ITALY |

SOLUTIONS COMPANY NEWS DOWNLOADS DEALER LOCATOR CONTACT

Logg in

If you have an account, please logg in.

Username

Password

ENTER

Forgotten your password? [Recover access](#)

Don't have account? [Request registration](#)

AIDIMME INSTITUTO TECNICO-CIENCO andimac ASCER ASOCIACION ESPAÑOLA DE POSICIONAMIENTO POR SATELITES Y SISTEMAS DE NAVEGACION ASO POSA Club Cámara VALENCIA IVEFA Proalso TILE OF SPAIN

New Online store

Our company has gone one step further in its digitalisation project. We now have an exclusive gift shop for distributors specialising in building materials. This is an exclusive, private space where you can purchase or obtain a free quote for our more-than 5,000 references. Available in four languages, our store is designed to optimise operation in just a few clicks. It is connected directly to our ERP and therefore to our stock. So it compiles all technical information and all the various aesthetic possibilities at the time of purchase.

EMAC® Group thus concludes a year of success in sales and digital transformation as a result of putting people at the heart of our strategy.





EMAC® Group

Construction Division - EMAC®

Valencia, España

info@emac.es | Tel. (+34) 961 532 200 | www.emac.es

Miami, Florida, EEUU

info@emac-america.com | Phone. # (305) 406 1593 | www.emac-america.com

Sassuolo (Mo), Italia

info@emac-italia.it | Tel. (+39) 0536994854 | www.emac-italia.it

Artistic Division – ®Artelux

projects@artelux.es | Tel. (+34) 961 540 366 | www.arteluxcontract.com | www.artelux.es



SOCI AGGREGATI



SOCI COOPERATIVO



Marca de Alto Potencial Internacional
Acreditada por el Foro de Marcas
Renombradas Españolas

