

# SOLUTIONS FOR PROJECTS

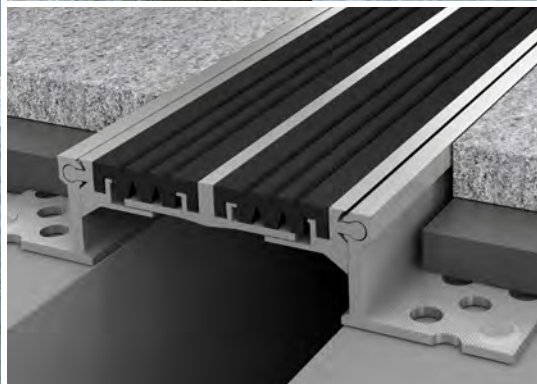

**STRUCTURAL JOINTS**  
**EXPANSION JOINTS**  
**PROFILES**  
**TECHNICAL MATS**

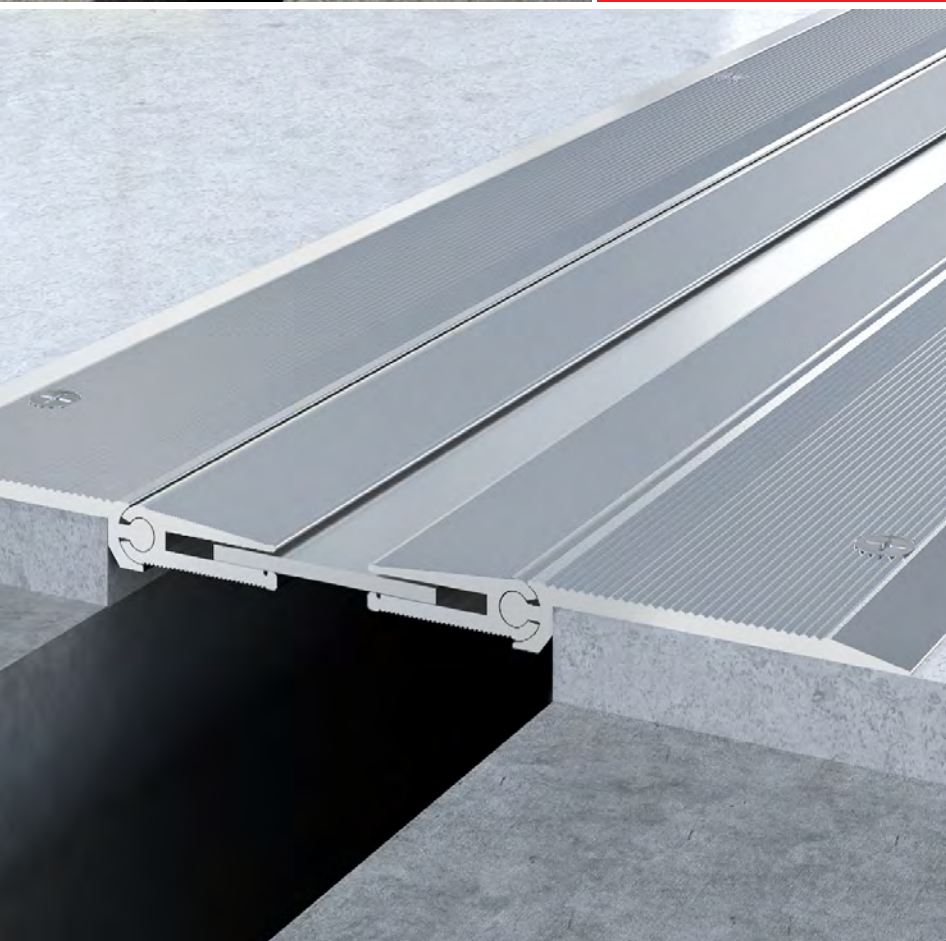

STRUCTURAL EXPANSION  
JOINTS AND  
CONSTRUCTION PROFILES



# INDEX

1. WHAT ARE EXPANSION JOINTS?	08
2. WHAT DO YOU NEED TO CHOOSE THE ADEQUATE EXPANSION JOINT?	10
3. EXPANSION JOINT SELECTION CHART	11

## PRODUCT INDEX

### 4. EXPANSION JOINTS FLUSH WITH THE FLOORING - W/ ELASTIC INSERT 13 - 24



Novojunta® Pro Basic Slimm



Novojunta® Pro Basic



Novojunta® Pro Aluminio



Novojunta® Pro L50



Novojunta® Pro L55



Novojunta® Pro L65



Novojunta® Pro L85



Novojunta® Pro XL105



Novojunta® Pro XL130



Novojunta® Pro WP80 Watertight

### 5. EXPANSION JOINTS FLUSH WITH THE FLOORING - ALL METAL 25 - 37



Novojunta® Pro AL30 RS



Novojunta® Pro Móvil



Novojunta® Pro Metal 30



Novojunta® Pro Metal 45



Novojunta® Pro Metal 50



Novojunta® Pro Metal 60



Novojunta® Pro Metal 80



Novojunta® Pro Metal 100



Novojunta® Pro Metal SIS110



Novojunta® Pro Metal SIS125



Novojunta® Pro Metal SIS

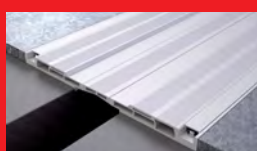

Novojunta® Pro Sismo SU

## 6. OVERLAPPED EXPANSION JOINTS

38 - 47



Novojunta® Pro Basic SP



Novojunta® Pro AL30



Novojunta® Pro Antidesl.

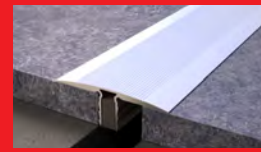

Novojunta® Pro Decor



Novojunta® Pro SP



Novojunta® Pro Sismo PE



Novojunta® Pro Metal SP50



Novojunta® Pro Metal SP100

## 7. VERTICAL EXPANSION JOINTS

48 - 52



Novojunta® Pro PA



Novojunta® Pro PASP



Novojunta® Pro Sismo PA

## 8. EXPANSION JOINTS SYSTEM COMPLEMENTS

53 - 55



Novomembrana EPDM



Firestop Cords

## 9. RETRACTING JOINTS



Novojunta® Concrete

## 10. COVERPLATES

58 - 62



Novotapajuntas NDP

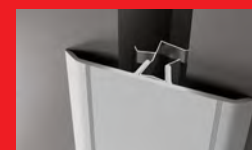

Novotapajuntas NDA



Novotapajuntas NCJE

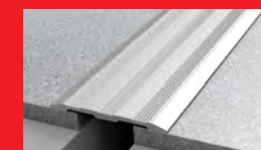

Novotapajuntas GTA

## 11. MOVEMENT JOINTS

63 - 73



Novojunta® Metallic



Novojunta® Metallic Perim.



Novojunta® Decor



Novojunta® Decor XL



Novojunta® Metallic Flecha

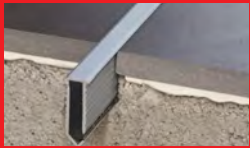

Novojunta® Decor Flecha



Novojunta® 1 PVC



Novojunta® 2 PVC



Novojunta® 3 PVC



Novojunta® Metallic Flex



Novojunta® Maxi

## 12. PROFILES AND COMPLEMENTS

74 - 86



Novopared ASTRA® Kombu



Novotri Eclipse®



Novopilastra®



Novobisel®



Novolistel® 3 XS



Novolistel® 3 Aluminio



Novocanto®



Novopared-Novosuelo



Novoescuadra Aluminio



Novoescuadra XL PVC



Novoescuadra Plus



Novoyeso

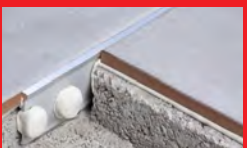

Novosepara 1



Novosepara 4



Novosepara 5



Novosepara 10



Novoescocia® S



Novoescocia® 4



Monocapa



Novovierteaguas GT

## 13. SKIRTINGS / BASEBOARDS

87 - 90

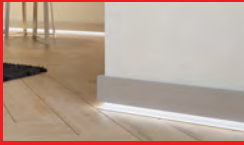

Novorodapie Eclipse® SP



Novorodapie Eclipse®



Novorodapie® Semiflex



Novorodapie® Rehabit



Novorodapie® L

## 14. STAIR NOSING

91 - 97



Novopeldaño ASTRA® Nori



Novopeldaño Eclipse®



Novopeldaño® 4

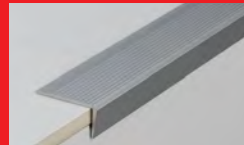

Novopeldaño® 5



Novopeldaño® MaxiKenya



Novopeldaño® MaxiDakar

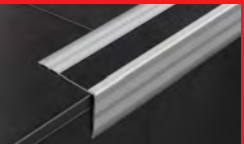

Novopeldaño® Safety



Novopeldaño® Safety Plus

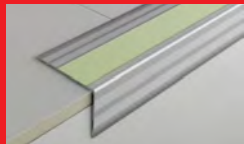

Novopeldaño Lúmina®



Novopeldaño Lúmina® Plus

## 15. UNIVERSAL ACCESSIBILITY AND SAFETY

98 - 105

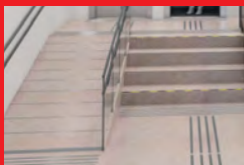

Sistema Podotáctil de  
Accesibilidad Universal

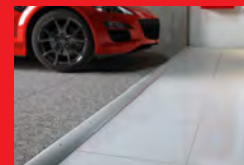

Novonivel® Access XT20

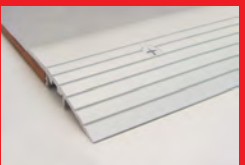

Novonivel® Access Slimm



Novonivel® Access



Novonivel® Forte



Novostrip - Novostrip SP

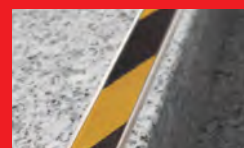

Novopletina® Safety



Novopletina Lumina®



Novopletina® Aluminio

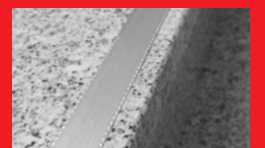

Novopletina® Acero Inox.

## 16. TECHNICAL ENTRANCE MATS

106 - 109

## 17. DESIGN, DEVELOPMENT AND TECHNICAL SUPPORT

110 - 112

# 1. WHAT ARE EXPANSION JOINTS?

All buildings and their structural elements are subject to stresses which cause movements, deformations and dimensional changes.

## THESE STRESSES ARE CAUSED BY THE FOLLOWING REASONS:

- Thermal changes in the environment.
- Expansion and contraction of constructive elements.
- Settlements and movements of the ground
- Seismic movements.
- The use.
- Wind pressure.
- Loads and traffic.

To control and prevent these stresses, the medium and large buildings are built by blocks, so that each block works individually and does not hit the adjacent block.

Between these blocks some spaces are left as expansion joints. The location and width of these spaces are determined by structural engineers, who also will determine the load capacity of the profile selected.

An expansion joint is a space that crosses the whole structure of the building: floors, walls, facades and ceilings.

The structural expansion joints absorb the movements of the building to control and prevent from the apparition of different pathologies in the structure. They also isolate the encounters between different structural elements such as walls, pillars, sinks, etc., avoiding the transmission of stresses between them.

Do not install expansion joints, use an improper joint system or distribute them incorrectly can cause all kind of pathologies in the structure or the building finishes. Once the construction is finished these pathologies will be very difficult to solve and will result in a high maintenance cost. Instead, solving adequately the encounters and critical elements in the building identifies a good project.

The profiles for expansion joints are installed in all kind of projects, specially in airports, malls, hospitals, schools, parkings, industrial buildings, factories... given their features and dimensions. These profiles generally consist of aluminum profiles with a rubber insert or are systems entirely made of metal. Their function is covering the expansion joint gap to allow the free movement of the blocks without causing damage in the concrete or the tiling.

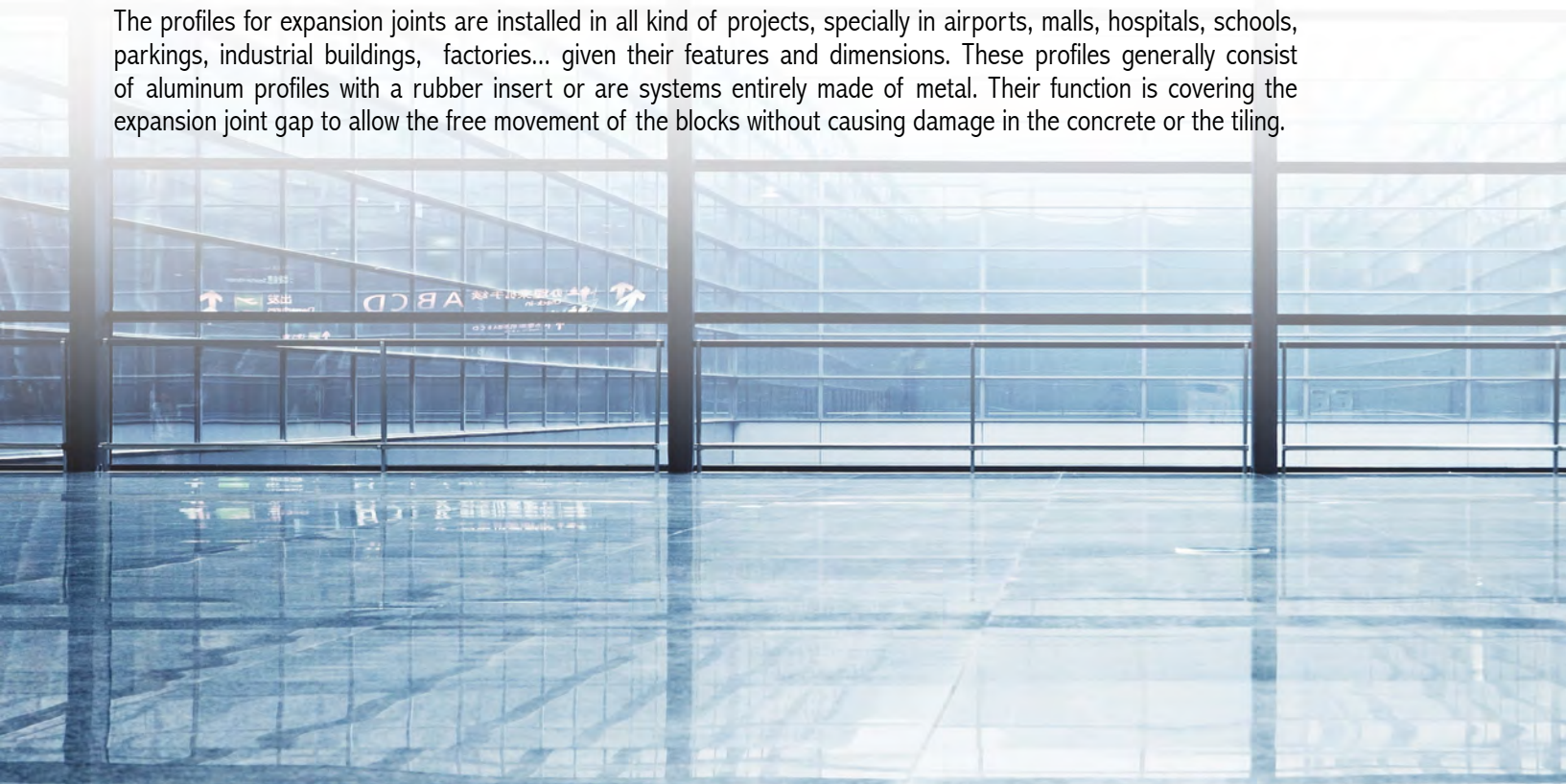



## WHAT IS A STRUCTURAL JOINTS SYSTEM AND WHY INSTALL IT?

The Structural Joints System is an assembly designed to be installed in structural expansion joints consisting of three independent elements:

1. **Structural joint profile (Novojunta® Pro)**
2. **Novomembrana EPDM**
3. **Firestop cord**

Its function is to resolve the joints in such a way that they are integrated into the building, enabling safe traffic, absorbing movements of the structure safely and protecting the installation against damp and the passage of flames in the event of fire.

Solving the structural joint using a suitable profile is a sound technical solution that will enable the building to move freely, thereby preventing the appearance of pathologies. Yet the passage of damp and steam, or the passage of flames and smoke in the event of fire can cause serious pathologies and even affect occupants' health. Not to take all such factors into account could mean that the most technical profile does not fulfil its function.

For this reason, it is recommended to install a complete Structural Joints System from the start, thereby helping to comply with safety regulations in the event of fire and preserving the state of the installation, avoiding the high costs of intervention or maintenance once the works have ended.

## WHERE TO INSTALL THE STRUCTURAL JOINTS SYSTEM?

The EMAC® Structural Joints System can be installed in all types of project where structural joints are employed. It is an element that is typically present in large projects such as airports, shopping centres, hospitals, education centres, parking facilities, industrial buildings, etc.

## THE EXPANSION JOINTS CAN BE CLASSIFIED AS FOLLOWS:

### ACCORDING TO ITS INSTALLATION:

- Overlapped, on the floor
- Flush with the flooring, at level

### ACCORDING TO THE LOAD SUPPORT:

- Light
- Medium
- Semi-heavy
- Heavy-duty



# 2. WHAT DO YOU NEED TO CHOOSE THE ADEQUATE EXPANSION JOINT?

## FUNDAMENTAL QUESTIONS TO BE RAISED:

1. What kind of installation do you need?

- Flush to the flooring
- Overlapped (finished floorings)

2. What is the width of the expansion joint?

3. What is the necessary height? (for flush to flooring joints)

4. What is the necessary load support?

LIGHT LOADS: 

MEDIUM LOADS:  OCASIONAL

SEMI-HEAVY LOADS: 

HEAVY-DUTY LOADS: 



### BEAR IN MIND:

EMAC® structural joints have accessories that are specially developed to ensure the joint's passive safety, using firestop cord or augmenting the waterproofing of the support using EPDM membranes. The use of such accessories is highly recommended and, in some cases, essential. Consult our information with no obligation.



Expansion Joint Profile



Expansion Joint Profile + Novomembrana EPDM



Expansion Joint Profile + Firestop Cord

## ADVICE AND TECHNICAL STUDY WITHOUT OBLIGATION

Our technical team is at your total disposal to solve your questions or to facilitate the technical info you need: technical files, constructive details in cad format, installation instructions...

If you prefer, send us your drawings and we will give you technical advice about recommendable distribution of the movement joints in your project.

# 4.EXPANSION JOINT SELECTION CHART

Use	Installation	Load	Reference	Max.joint width	Type	Page	
Floor or wall	Flush with the flooring	Medium	Novojunta® Pro Basic Slimm	40 mm	With elastic insert	15	
			Novojunta® Pro Basic	40 mm	With elastic insert	16	
			Novojunta® Pro Aluminio	55 mm	With elastic insert	17	
			Novojunta® Pro L50	50 mm	With elastic insert	18	
			Novojunta® Pro L85	85 mm	With elastic insert	21	
			Novojunta® Pro XL105	105 mm	With elastic insert	22	
			Novojunta® Pro XL130	130 mm	With elastic insert	23	
			Novojunta® Pro AL30 RS	30 mm	All meta	26	
			Novojunta® Pro Metal SIS110	110 mm	All metal. Seismic	34	
		Semi-heavy	Novojunta® Pro L55	55 mm	With elastic insert	19	
			Novojunta® Pro L65	65 mm	With elastic insert	20	
			Novojunta® Pro WP80	80 mm	Watertight	24	
		Heavy	Novojunta® Pro Móvil	50 mm	All metal	27	
			Novojunta® Pro Metal 30	30 mm	All metal	28	
			Novojunta® Pro Metal 45	45 mm	All metal	29	
			Novojunta® Pro Metal 50	50 mm	All metal	30	
			Novojunta® Pro Metal 60	60 mm	All metal	31	
			Novojunta® Pro Metal 80	80 mm	All metal	32	
			Novojunta® Pro Metal 100	100 mm	All metal	33	
			Novojunta® Pro Sismo SU	100 mm	All metal. Seismic	37	
			Novojunta® Pro Metal SIS125	125 mm	All metal. Seismic	35	
		Novojunta® Pro Metal SIS	200 mm	All metal. Seismic	36		
		Overlapped	Light	Novojunta® Pro Basic SP	40 mm	With elastic insert	40
				Novojunta® Pro Antideslizante	40 mm	With elastic insert	42
				Novojunta® Pro AL30	30 mm	All metal	41
			Medium	Novojunta® Pro Decor	30 mm	Metal + rubber	43
				Novojunta® Pro SP	50 mm	With elastic insert	44
Heavy	Novojunta® Pro Metal SP50		50 mm	All metal	45		
	Novojunta® Pro Metal SP100		100 mm	All metal	46		
Wall	Flush with the flooring		-	Novojunta® Pro PA	390 mm	With elastic insert.Seismic.	50
	Overlapped	-	Novojunta® Pro Sismo PE	74 mm	All metal. Seismic.	47	
		-	Novojunta® Pro Sismo PA	100 mm	All metal. Seismic.	52	
		-	Novojunta® Pro PASP	390 mm	With elastic insert.Seismic.	51	

EMAC Complementos, S.L. reserves the right to make at any time modifications to the geometry profile or the specifications of his products.

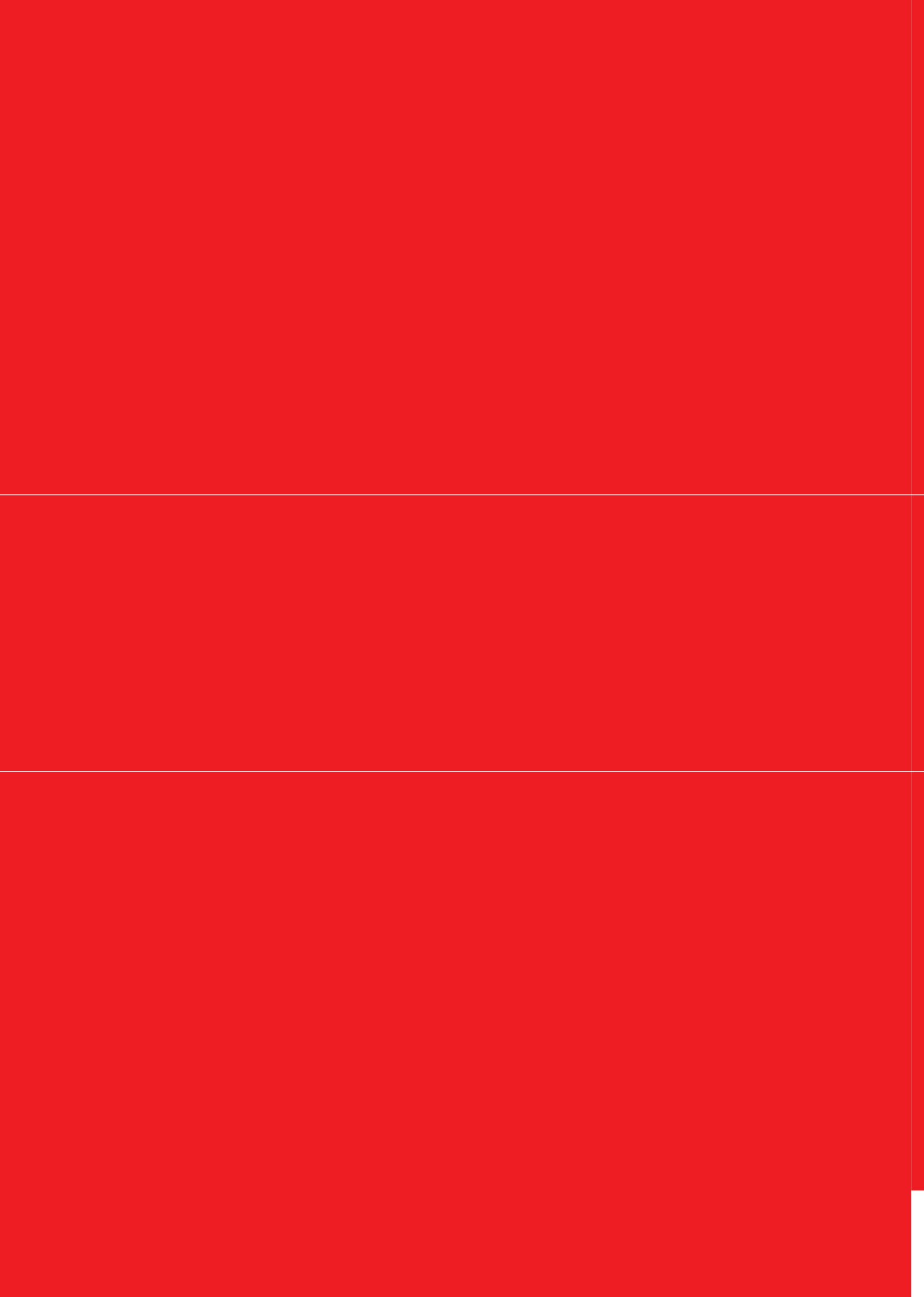

## 4. FLUSH WITH THE FLOORING WITH ELASTIC INSERT



Our Technical Department (tecnico@emac.es) may assist you choosing the most appropriate profile ensuring the correct application fulfilling the CTE (Spanish Technical Building Code) and the recommendations included in the Norm UNE 138002:2017 (General Regulations for the execution of wall and floor tiles by adhesion).



# NOVOJUNTA® PRO BASIC SLIMM

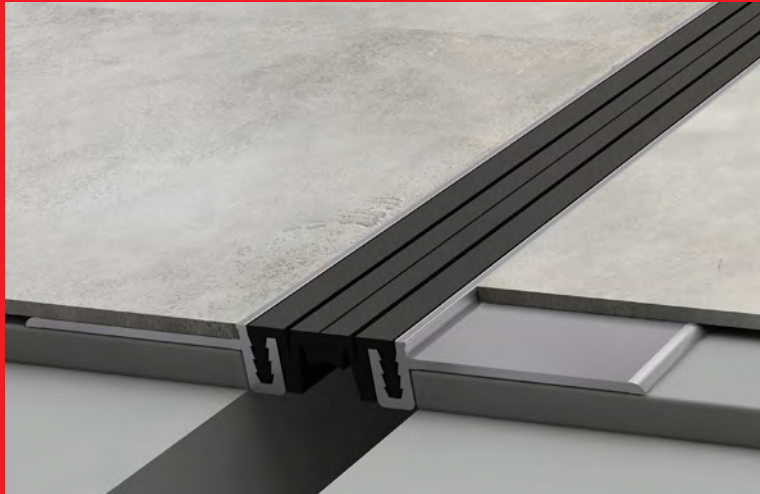

- System of profiles up to 40 mm width suited to be installed in low ceramic thickness like vinyl flooring or carpets among others.
- Two aluminium profiles with holes for the fixing screws and a central part made of high quality synthetic rubber that it is inserted into the aluminum profiles.
- Replaceable rubber insert supplied in rolls.
- Delivered unmounted
- Safe and easy fixing thanks to the perforated profiles and the fixing screws.
- 3 rubber widths available (20, 30 y 40 mm /0.78", 1.18", 1.57")), flat or striated.

## TYPE OF RUBBER

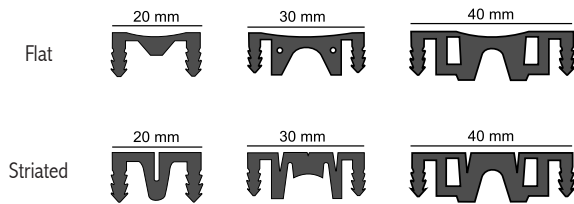

## RUBBER COLOUR

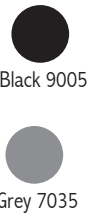

## MATERIALS AND TECHNICAL DETAILS

- Aluminum profiles drilled on the base for the fixing screws.
- High performance rubber insert with ability to absorb multidirectional movements. Excellent mechanical properties, great elasticity, good weatherability, UV and abrasion resistant, support thermal variations (-30°C / +120°C).
- Profiles delivered in 2.5 m. length (98.42")
- The rubber insert is delivered separately
- The whole system includes all the fixing screws\*\*

Novojunta® Pro Basic Slimm h:3 mm.

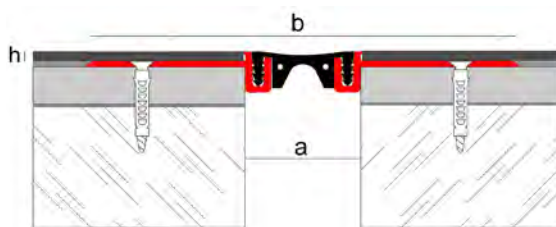

Download the EMAC® app from the App Store and Google Play



REFERENCE	Joint width (a)	Total width (b)	Profile height (h)	Type of rubber	Movement flat rubber	Movement striated rubber
NJPB2003*	20 mm	124 mm	3 mm	flat or striated	8 mm (+4/-4)	10 mm (+5/-5)
NJPB3003*	30 mm	134 mm		flat or striated	10 mm (+5/-5)	12 mm (+6/-6)
NJPB4003*	40 mm	144 mm		flat or striated	12 mm (+6/-6)	14 mm (+7/-7)

\* Indicate the desired type (flat or striated) and colour of the rubber

# NOVOJUNTA® PRO BASIC

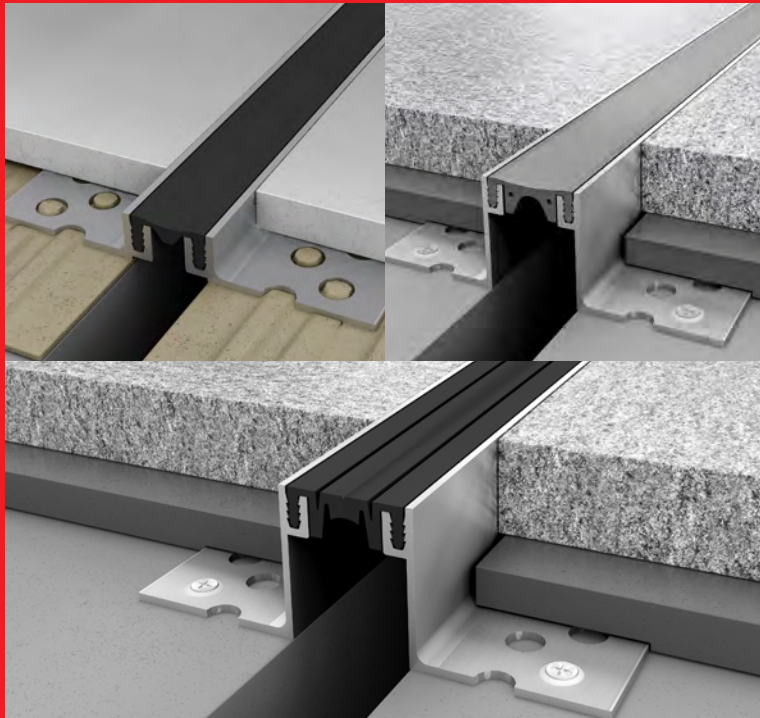

- Expansion joints in floorings (ceramics, concrete, terrace, stone...).
- For joint widths up to 40 mm (1.57")
- Movement allowed up to 14 mm (0.55")
- Replaceable rubber insert
- Delivered unmounted
- Safe and easy fixing thanks to the perforated profiles and the fixing screws.
- 5 heights available: 12,5, 22, 40, 50 y 80 mm (0.49, 0.86, 1.57, 1.96, 3.14")
- 3 rubber widths available (20, 30 y 40 mm /0.78",1.18",1.57"), flat or striated.
- It can be installed between floorings at different level by combining the aluminum profiles with different height each side.

## MATERIALS AND TECHNICAL DETAILS

- Aluminum profiles with "L" shape, drilled on the base for the fixing screws.
- High performance rubber insert with ability to absorb multidirectional movements. Excellent mechanical properties, great elasticity, good weatherability, UV and abrasion resistant, support thermal variations (-30°C / +120°C).
- Available in option firestop cords or membrane depending on the model (consult)
- Profiles delivered in 3 m. length (118.11")
- The rubber insert is delivered separately
- The whole system includes all the fixing screws\*\*

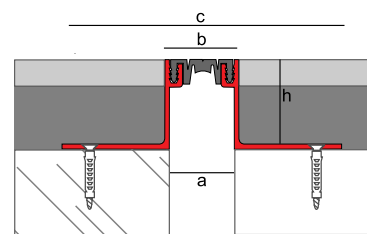
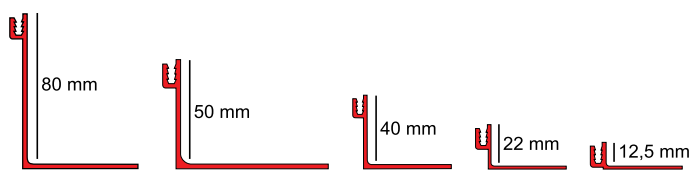
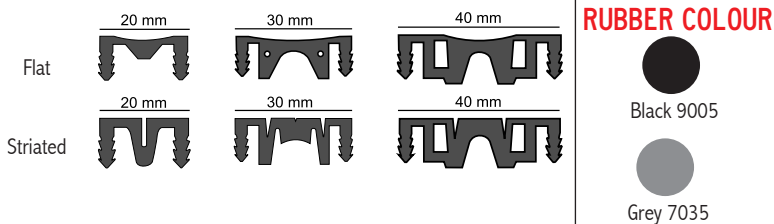

Download the EMAC® app from the App Store and Google Play



REFERENCE	Joint width (a)	Visible width (b):	Total width (c):	h):	Type of rubber	Movement flat rubber	Movement striated rubber
Expansion joints up to 25 mm width							
NJPB2012*	20 mm / 0.78"	24 mm / 0.94"	104 mm/4.09"	12.5 mm/0.49"	flat or striated	8 mm (+4/-4) 0.31" (+0.15/-0.15")	10 mm (+5/-5) 0.39" (+0.19/-0.19")
NJPB2022*			104 mm/4.09"	22 mm/0.86"			
NJPB2040*			120 mm/4.72"	40 mm/1.57"			
NJPB2050*			160 mm/6.29"	50 mm/1.96"			
NJPB2080*			130 mm/5.11"	80 mm/3.14"			
Expansion joints up to 35 mm width							
NJPB3012*	30 mm / 1.18"	34 mm / 1.33"	114 mm/4.48"	12.5 mm/0.49"	flat or striated	10 mm (+5/-5) 0.39" (+0.19/-0.19")	12 mm (+6/-6) 0.47" (+0.23/-0.23")
NJPB3022*			114 mm/4.48"	22 mm/0.86"			
NJPB3040*			130 mm/5.11"	40 mm/1.57"			
NJPB3050*			170 mm/6.69"	50 mm/1.96"			
NJPB3080*			140 mm/5.51"	80 mm/3.14"			
Expansion joints up to 45 mm width							
NJPB4012*	40 mm / 1.57"	44 mm / 1.73"	124 mm/4.88"	12.5 mm/0.49"	flat or striated	12 mm (+6/-6) 0.47" (+0.23/-0.23")	14 mm (+7/-7) 0.55" (+0.27/-0.27")
NJPB4022*			124 mm/4.88"	22 mm/0.86"			
NJPB4040*			140 mm/5.51"	40 mm/1.57"			
NJPB4050*			180 mm/7.08"	50 mm/1.96"			
NJPB4080*			150 mm/5.90"	80 mm/3.14"			

\* Indicate the desired type (flat or striated) and colour of the rubber

\*\* Fixing screws included ref. FIJAC8X60TG - 6 u/complete meter of joint



EMAC COMPLEMENTOS, S.L. • Avda. Madrid 6 • 46930 Quart de Poblet, Valencia, Spain • Tel.: (+34) 961 532 200 - Fax: (+34) 961 532 261 • info@emac.es  
 EMAC ITALIA S.R.L. • Via Emilia-Romagna 104 • 41049 Sassuolo (Mo), Italia • Tel.: (+39) 0536994854 - Fax: (+39) 0536889025 • info@emac-italia.it  
 EMAC AMERICA, L.L.C. • 1970 NW 129 Avenue, Unit # 103 • Miami, FL 33182 • Phone: # (305) 406 1593 - Fax: (305) 406 1793 • info@emac-america.com

en.emac.es



Reg. 869888-5



# NOVOJUNTA® PRO ALUMINIO

Model registered as community design No 869892-5

- Expansion joints in floorings (ceramics, concrete, terrace, stone...).
  - For joint widths up to 55 mm (2.16")
  - Movement allowed up to 22 mm. (0.86")
  - Replaceable rubber insert
  - Easy and safe fixing with screws (not included)
- Consult the screw recommendation in the technical file.
- Is delivered mounted with protective film



## MATERIALS AND TECHNICAL DETAILS

- Aluminum profiles with "L" shape, drilled on the base for the fixing screws (not included)
- High performance rubber insert with ability to absorb multidirectional movements. Excellent mechanical properties, great elasticity, good weatherability, UV and abrasion resistant, support thermal variations (-30°C / +120°C).
- Available in option firestop cords or membrane depending on the model (consult)

- Is delivered mounted with protective film
- For the 35 y 50 mm height models there are available alignment plates (for the installation) and reinforce pieces to increase its load support capacity.

## RUBBER COLOUR



Black 9005

Novojunta® Pro Aluminium h:20 mm

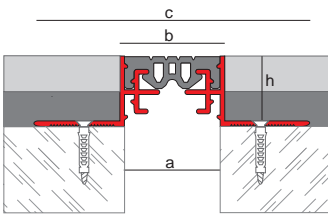

Novojunta® Pro Aluminium h:35 y 50 mm

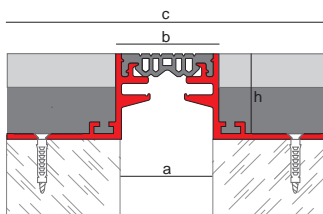

Novojunta® Pro Perimetral Enrasada

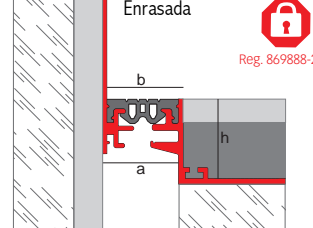

Novojunta® Pro Perimetral Superpuesta

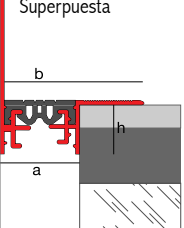

Novojunta® Pro Aluminium	Joint width (a)	Visible width (b)	Total width (c)	Profile height (h)	Type of rubber	Horizontal movement
Expansion joints up to 30 mm width						
NJPAL2034	30 mm/1.18"	34 mm/1.33"	87 mm/3.42"	20 mm/0.78"	striated	10 mm (+5/-5) 0.39" (+0.19/-0.19")
NJPAL3534*			130 mm/5.11"	35 mm/1.37"		
NJPAL5034*			130 mm/5.11"	50 mm/1.96"		
Expansion joints up to 40 mm width						
NJPAL2044	40 mm/1.57"	44 mm/1.73"	97 mm/3.81"	20 mm/0.78"	striated	14 mm (+7/-7) 0.55" (+0.27/-0.27")
NJPAL3544*			140 mm/5.51"	35 mm/1.37"		
NJPAL5044*			140 mm/5.51"	50 mm/1.96"		
Expansion joints up to 55 mm width						
NJPAL3559*	55 mm/2.16"	59 mm/2.32"	155 mm/6.10"	35 mm/1.37"	striated	20 mm (+10/-10) 0.78" (+0.39/-0.39")
NJPAL5059*			155 mm/6.10"	50 mm/1.96"		

\* Adding the reinforce central piece increase the load support.

Novojunta® Pro Périètre Enrasada	Joint width (a)	Visible width (b)	Profile height (h)	Type of rubber	Horizontal movement
Expansion joints up to 32 mm width					
NJPPS2032	32 mm/1.25"	32 mm/1.25"	20 mm/0.78"	striated	10 mm (+5/-5) 0.39" (+0.19/-0.19")
NJPPS3532			35 mm/1.37"		
NJPPS5032			50 mm/1.96"		
Expansion joints up to 42 mm width					
NJPPS2042	42 mm/1.65"	42 mm/1.65"	20 mm/0.78"	striated	14 mm (+7/-7) 0.55" (+0.27/-0.27")
NJPPS3542			35 mm/1.37"		
NJPPS5042			50 mm/1.96"		

Novojunta® Pro Périètre Superpuesta	Joint width (a)	Visible width (b)	Profile height (h)	Type of rubber	Horizontal movement
NJPPS2058	34 mm/1.33"	58 mm/2.28"	20 mm/0.78"	striated	10 mm (+5/-5) / 0.39" (+0.19/-0.19")
NJPPS2068	44 mm/1.73"	68 mm/2.67"	20 mm/0.78"	striated	14 mm (+7/-7) / 0.55" (+0.27/-0.27")

Download the EMAC® app from the App Store and Google Play



EMAC Complementos, S.L. reserves the right to make at any time modifications to the geometry profile or the specifications of his products.



# NOVOJUNTA® PRO L50

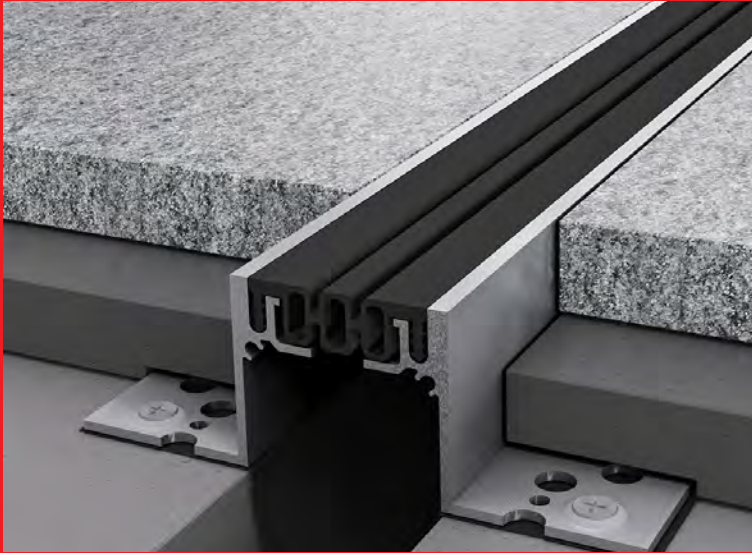

- Expansion joints in floorings (ceramics, concrete, terrace, stone...).
- For joint widths up to 50 mm (1.96")
- Movement allowed up to 20 mm (0.78")
- Replaceable rubber insert
- Safe and easy fixing thanks to the perforated profiles and the fixing screws.
- Is delivered unmounted

## RUBBER COLOUR



## MATERIALS AND TECHNICAL DETAILS

- Aluminum profiles with "L" shape, drilled on the base for the fixing screws.
- High performance rubber insert with ability to absorb multidirectional movements. Excellent mechanical properties, great elasticity, good weatherability, UV and abrasion resistant, support thermal variations (-30°C / +120°C).
- Available in option firestop cords or membrane depending on the model (consult)
- Striated or flat rubber insert
- Profiles delivered in 3 m. length (118.11")
- The rubber insert is delivered separately in rolls
- The whole system includes all the fixing screws\*

Novojunta® Pro L50

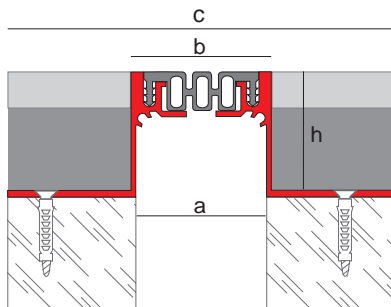

Angle version

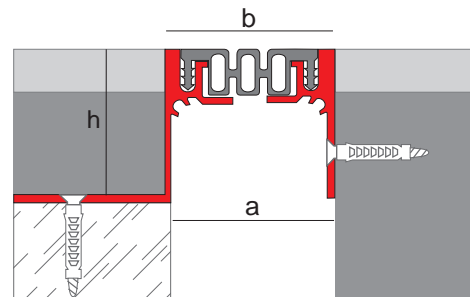

REFERENCE	Joint width (a)	Visible width (b)	Total width (c)	Profile height (h)	Type of rubber	Horizontal movement flat rubber	Horizontal movement striated rubber
NJPL50AL35NA	50 mm / 1.96"	55 mm / 2.16"	155 mm / 6.10"	35 mm/1.37"	lisa o estriada	16 mm (±8) 0.62" (±0.31")	20 mm (±10) 0.78" (±0.39")
NJPL50AL50NA				50 mm/1.96"			
NJPL50AL80NA				80 mm/3.14"			

\* Fixing screws included ref. FIJAC8X60TG - 6 u/complete meter of joint



# NOVOJUNTA® PRO L55

- Expansion joints in floorings (ceramics, concrete, terrace, stone...).
- For joint widths up to 55 mm (2.16")
- Movement allowed up to 24 mm (0.94")
- Replaceable rubber insert
- Safe and easy fixing thanks to the perforated profiles and the fixing screws.
- Is delivered pre-mounted

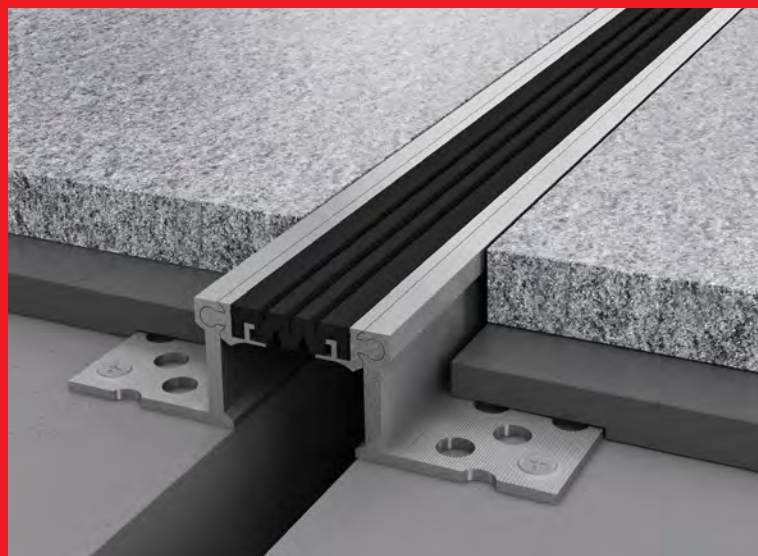

## MATERIALS AND TECHNICAL DETAILS

- Reinforced aluminum profiles with "L" shape, drilled on the base for the fixing screws, assembled by means of a ball-and-socket system which supports the rubber and allows the vertical movement.
- High performance rubber insert with ability to absorb multidirectional movements. Excellent mechanical properties, great elasticity, good weatherability, UV and abrasion resistant, support thermal variations (-30°C / +120°C).
- Available in option firestop cords or membrane depending on the model (consult)
- Profiles delivered in 3 m. length (118.11")
- The rubber insert is delivered in 25 m rolls (984.25")
- The whole system includes all the fixing screws\*

## RUBBER COLOUR



Novojunta® Pro L55

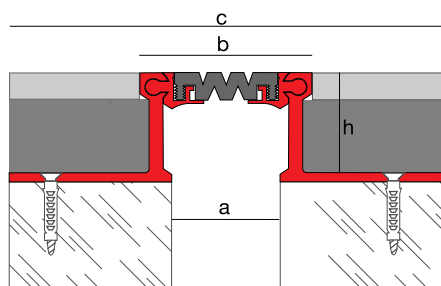

Angle version

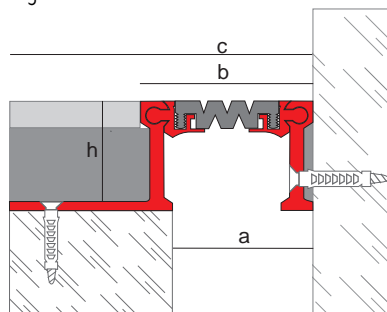

REFERENCE	Joint width (a)	Visible width (b)	Total width (c)	Profile height (h)	Type of rubber	Horizontal movement	Vertical movement
NJPL55AL18NA	55 mm/2.16"	80 mm/3.14"	195 mm/7.67"	18 mm/0.70"	estriada	24 mm (±12) 0.94"(±0.47")	10 mm (±5) 0.39" (±0.19")
NJPL55AL35NA				35 mm/1.37"			
NJPL55AL50NA				50 mm/1.96"			
NJPL55AL80NA				80 mm/3.14"			

\* Fixing screws included ref. FIJAC8X60TG - 6 u/complete meter of joint

# NOVOJUNTA® PRO L65

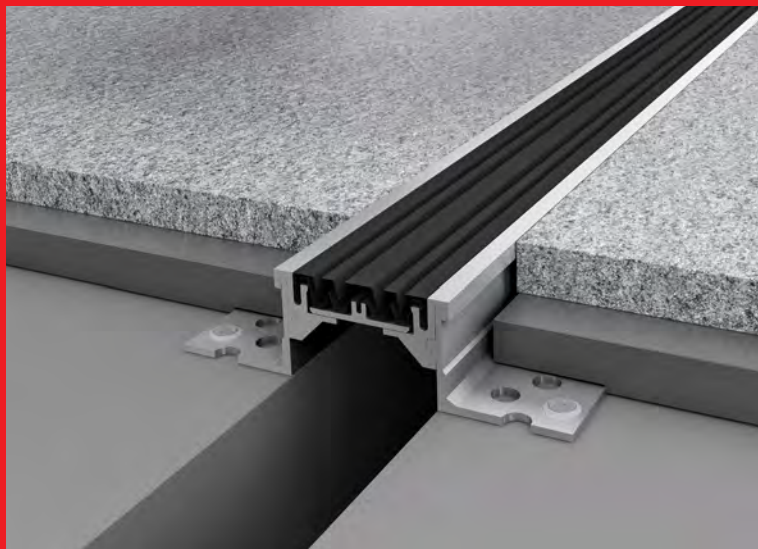

- Expansion joints in floorings (ceramics, concrete, terrace, stone...).
- For joint widths up to 65 mm (2.55")
- Movement allowed up to 36 mm (1.41")
- Replaceable rubber insert
- Safe and easy fixing thanks to the perforated profiles and the fixing screws.
- Is delivered pre-mounted

## RUBBER COLOUR



Black 9005



Grey 7035

## MATERIALS AND TECHNICAL DETAILS

- Reinforced aluminum profiles, drilled on the base for the fixing screws, assembled with two solid pieces and a central piece which supports the rubber profile
- High performance rubber insert with ability to absorb multidirectional movements. Excellent mechanical properties, great elasticity, good weatherability, UV and abrasion resistant, support thermal variations (-30°C / +120°C).
- Available in option firestop cords or membrane depending on the model (consult)
- Profiles delivered in 3 m. length (118.11")
- The rubber insert is delivered in continuous rolls
- The whole system includes all the fixing screws\*

Novojunta® Pro L65

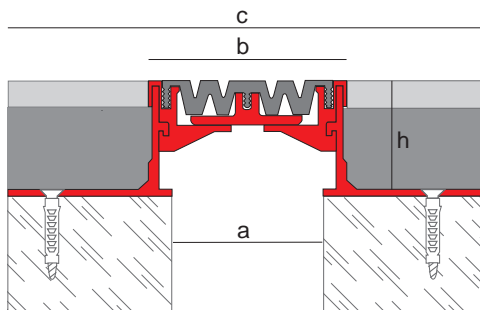

REFERENCE	Joint width (a)	Visible width (b)	Total width (c)	Profile height (h)	Type of rubber	Horizontal movement
NJPL65AL35NA	65 mm/2.55"	83 mm/3.26"	205 mm/8.07"	35 mm/1.37"	estriada	36 mm (±18) 1.41" (±0.70")
NJPL65AL50NA				50 mm/1.96"		

\* Fixing screws included ref. FIJAC8X60TG - 6 u/comple meter of joint



# NOVOJUNTA® PRO L85

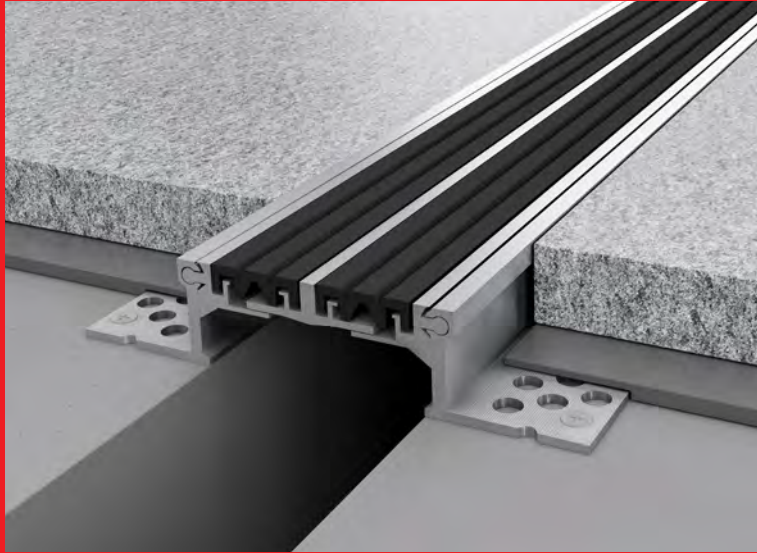

- Expansion joints in floorings (ceramics, concrete, terrace, stone...).
- For joint widths up to 85 mm (3.34")
- Movement allowed up to 20 mm (0.78")
- Replaceable rubber insert (2x40 mm/2x1.57")
- Safe and easy fixing thanks to the perforated profiles and the fixing screws.
- Is delivered pre-mounted

## MATERIALS AND TECHNICAL DETAILS

- Reinforced aluminum profiles with "L" shape, drilled on the base for the fixing screws, assembled by means of a ball-and-socket system which supports the rubber and allows the vertical movement. On the side pieces there is a large reinforcement profile which improves the load capacity support and serves to accommodate the rubber profiles.
- Double high performance rubber insert with ability to absorb multidirectional movements. Excellent mechanical properties, great elasticity, good weatherability, UV and abrasion resistant, support thermal variations (-30°C / +120°C).
- Available in option firestop cords or membrane depending on the model (consult)
- Profiles delivered in 3 m. length (118.11")
- The rubber insert is delivered in continuous rolls
- The whole system includes all the fixing screws\*

## RUBBER COLOUR



Novojunta® Pro L85

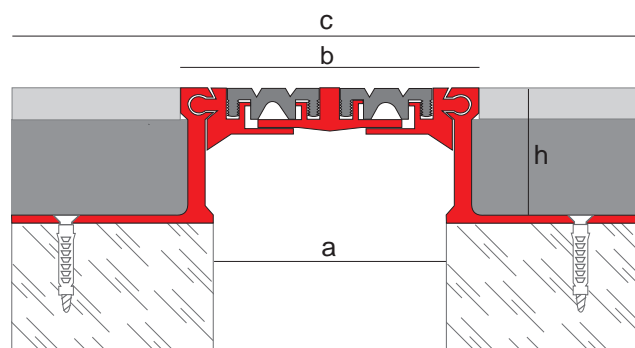

REFERENCE	Joint width (a)	Visible width (b)	Total width (c)	Profile height (h)	Type of rubber	Horizontal movement
NIPL85AL35NA	85 mm/3.34"	111 mm/4.37"	226 mm/8.89"	35 mm/1.37"	estriada	20 mm (±10) 0.78" (±0.39")
NIPL85AL50NA				50 mm/1.96"		
NIPL85AL80NA				80 mm/3.14"		

\* Fixing screws included ref. FIJAC8X60TG - 6 u/completer meter of joint

# NOVOJUNTA® PRO XL 105

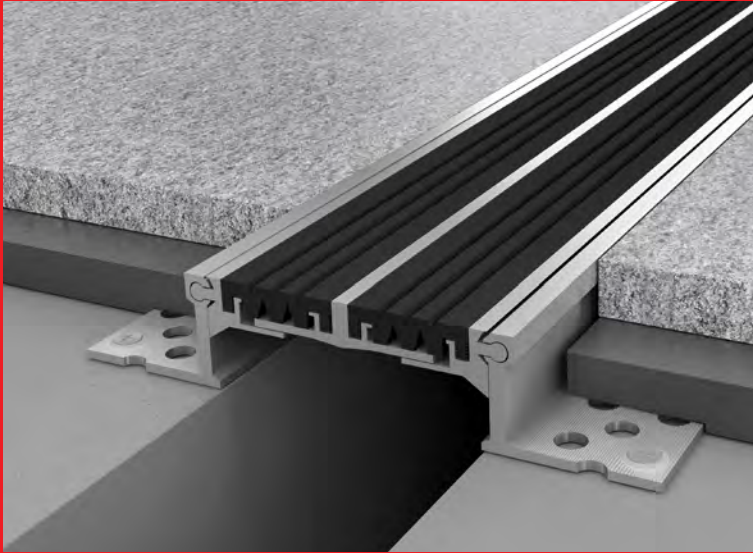

- Expansion joints in floorings (ceramics, concrete, terrace, stone...).
- For joint widths up to 105 mm (4.13")
- Movement allowed up to 20 mm (0.78")
- Replaceable rubber insert (2x50 mm)
- Safe and easy fixing thanks to the perforated profiles and the fixing screws.
- Is delivered pre-mounted

## MATERIALS AND TECHNICAL DETAILS:

- Reinforced aluminum profiles with "L" shape, drilled on the base for the fixing screws, assembled by means of a ball-and-socket system which supports the rubber and allows the vertical movement. On the side pieces there is a large reinforcement profile which improves the load capacity support and serves to accommodate the rubber profiles.
- High performance double rubber insert with ability to absorb multidirectional movements. Excellent mechanical properties, great elasticity, good weatherability, UV and abrasion resistant, support thermal variations (-30°C / +120°C).
- Available in option firestop cords or membrane depending on the model (consult)
- Profiles delivered in 3 m. length (118.11")
- The rubber insert is delivered in continuous rolls
- The whole system includes all the fixing screws\*

## RUBBER COLOUR



Novojunta® Pro XL105

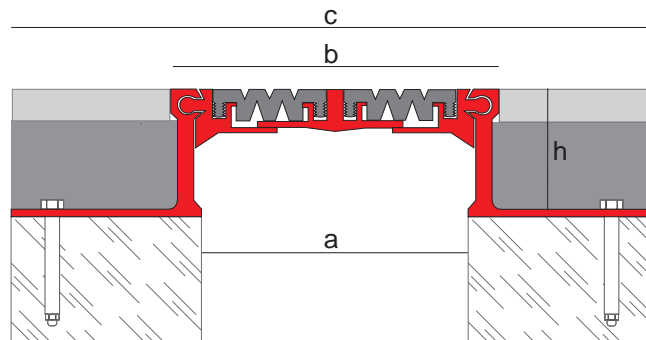

REFERENCE	Joint width (a)	Visible width (b)	Total width (c)	Profile height (h)	Type of rubber	Horizontal movement
NJPXL105AL18	105 mm/4.13"	130 mm/5.11"	236 mm/9.29"	18 mm/0.70"	estriada	20 mm (±10) 0.78" (±0.39")
NJPXL105AL35				35 mm/1.37"		
NJPXL105AL50				50 mm/1.96"		
NJPXL105AL80				80 mm/3.14"		

\* Fixing screws included ref. FIJAC&X60TG - 6 u/completer meter of joint

# NOVOJUNTA® PRO XL 130



- Expansion joints in floorings (ceramics, concrete, terrace, stone...).
- For joint widths up to 130 mm (5.11")
- Movement allowed up to 36 mm (1.41")
- Replaceable rubber insert (3X45 mm / 3x1.77")
- Safe and easy fixing thanks to the perforated profiles and the fixing screws.
- Is delivered pre-mounted

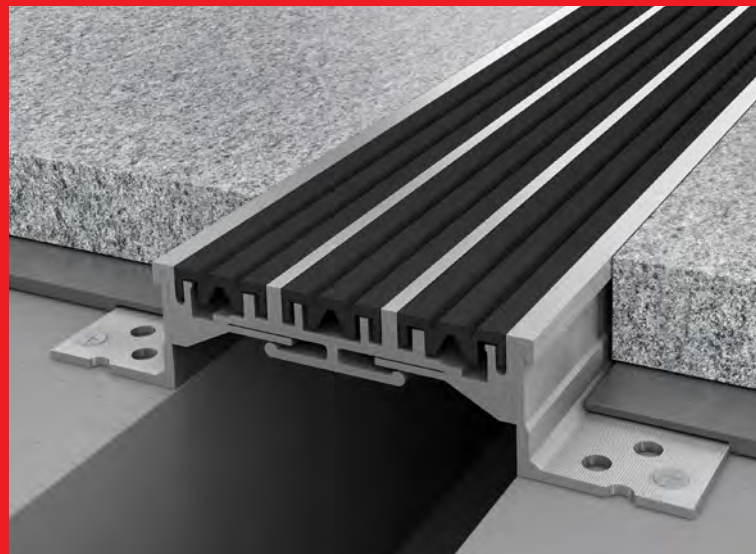

## MATERIALS AND TECHNICAL DETAILS:

- Aluminum profiles with "L" shape, drilled on the base for the fixing screws and central support reinforced.
- High performance triple rubber insert with ability to absorb multidirectional movements. Excellent mechanical properties, great elasticity, good weatherability, UV and abrasion resistant, support thermal variations (-30°C / +120°C).
- Available in option firestop cords or membrane depending on the model (consult)
- Profiles delivered in 3 m. length (118.11")
- The rubber insert is delivered in continuous rolls
- The whole system includes all the fixing screws\*

## RUBBER COLOUR



Novojunta® Pro XL130

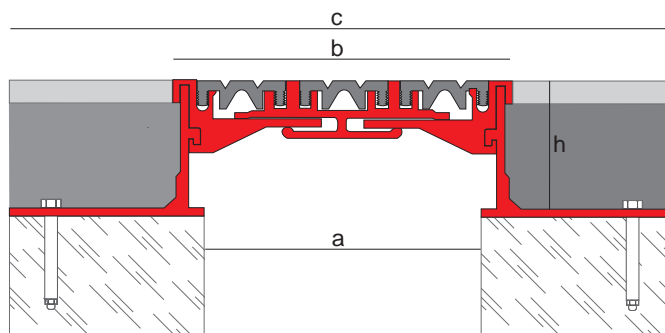

REFERENCE	Joint width (a)	Visible width (b)	Total width (c)	Profile height (h)	Type of rubber	Horizontal movement
NIPXL130AL35	130 mm/5.11"	155 mm/6.10"	274 mm/10.78"	35 mm/1.37"	striated	36 mm (±18) 1.41" (±0.70")
NIPXL130AL50				50 mm/1.96"		

\* Fixing screws included ref. FIJAC8X60TG - 6 u/complete meter of joint

# NOVOJUNTA® PRO WP80

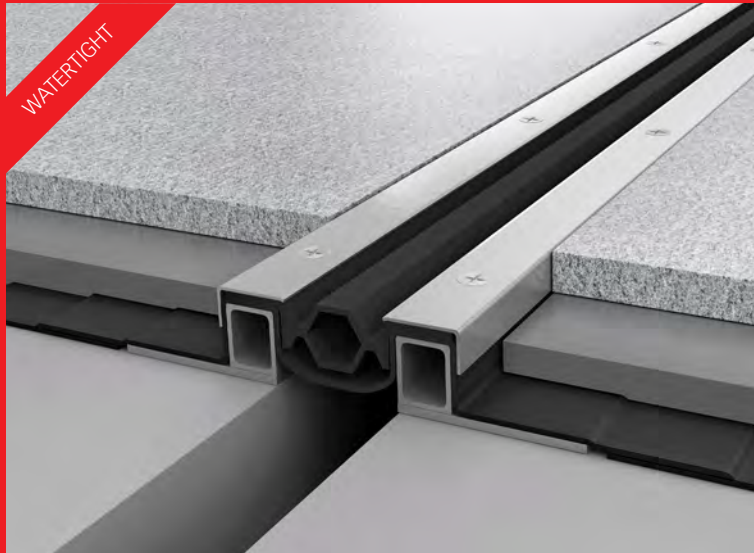

- Watertight expansion joint.
- Expansion joints in floorings (ceramics, concrete, terrace, stone...).
- For joint widths up to 80 mm (3.14")
- Movement allowed up to 60 mm (2.36")
- Supports semi-heavy loads.
- Ideal for outdoor parking lots of various heights, and structures that require waterproof joints to moisture, hygienic areas, etc.
- It is delivered unmounted.

## MATERIALS AND TECHNICAL DETAILS:

- Made of steel structure
- Anti-vibration rubber.
- EPDM elastic insert with additional membrane WOLFIN IB.
- Interchangeable thermoplastic membranes compatible with bituminous sheets or PVC membranes
- Covered with 2 mm thickness AISI 304 stainless steel profiles.
- Resists atmospheric agents and thermal changes (-35°C hasta +120°C).
- Installation with fixing screws according to the installation instructions.
- The whole system includes all the fixing screws\*
- Available fire barrier system in option

## RUBBER COLOUR



Black 9005

Novojunta® Pro WP80

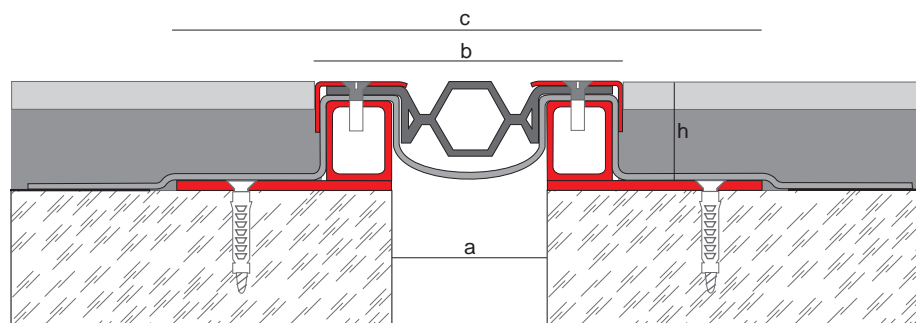

REFERENCE	Joint width (a)	Visible width (b)	Total width (c)	Profile height (h)	Horizontal movement	Vertical movement
NJPWP80AL54N	80 mm/3.14"	135 mm/5.31"	275 mm/10.82"	54 mm/2.12"	60 mm (±30) 2.36" (±1.18")	40 mm (±20)
NJPWP80AL64N				64 mm/2.51"		
NJPWP80AL94N				94 mm/3.70"		

\* Fixing screws included ref. kit T1NJPWP80 + ref. kit T2NJPWP80 - 1 ud. kit/complete meter of joint

## 5. FLUSH WITH THE FLOORING ALL METAL



Our Technical Department (tecnico@emac.es) may assist you choosing the most appropriate profile ensuring the correct application fulfilling the CTE (Spanish Technical Building Code) and the recommendations included in the Norm UNE 138002:2017 (General Regulations for the execution of wall and floor tiles by adhesion).



# NOVOJUNTA® PRO AL30 RS

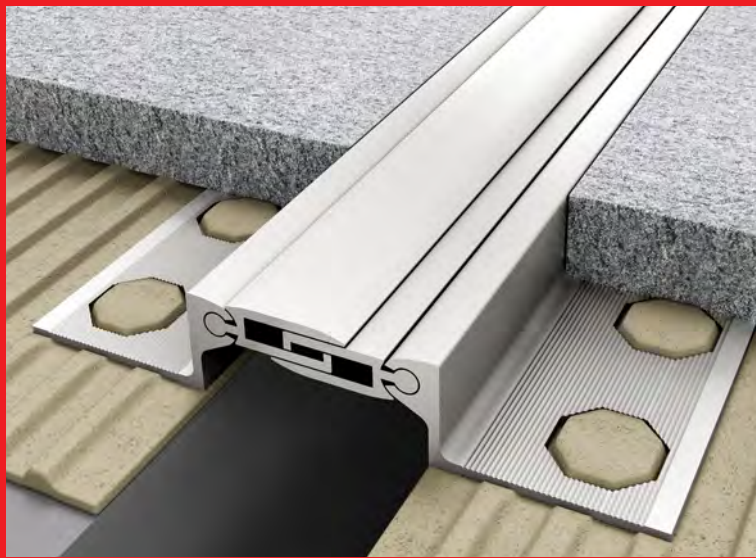

- Entirely made of aluminum expansion joint.
- Great durability. Does not require maintenance.
- Expansion joints in floorings (ceramics, concrete, terrace, stone...).
- For joint widths up to 30 mm (1.18")
- Movement allowed up to 9,4 mm (0.37")
- It is delivered mounted with protective film.

## AVAILABLE FINISHES



Silver matt anodized

## MATERIALS AND TECHNICAL DETAILS:

- Expansion joints consisting of sliding aluminum profiles.
- System of profiles with ability to absorb multidirectional movements
- Available in option firestop cords or membrane depending on the model (consult)
- Profiles delivered in 2.5 m. length (98.42")
- It is delivered mounted, with protective film

Novojunta® Pro AL30 RS

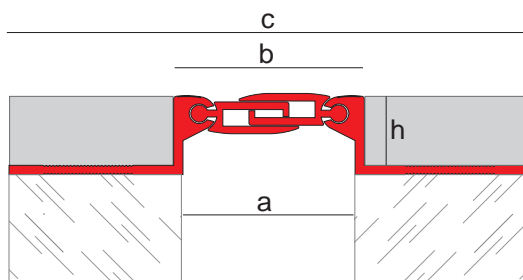

Novojunta® Pro AL30 RS Perimetral

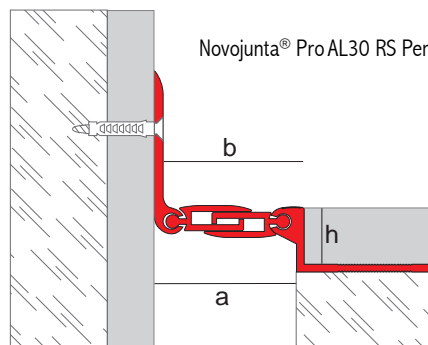

Download the EMAC® app from the App Store and Google Play



REFERENCE	Joint width (a)	Visible width (b)	Total width (c)	Profile height (h)	Horizontal movement	Vertical movement
NJPAL30RSPL	30 mm/1.18"	32.5 mm/1.27"	84 mm/3.30"	12.5 mm/0.49"	9,4 mm (+4,7/-4,7) 0.37" (+0.18/-0.18")	5 mm (+2.5/-2.5) 0.19" (+0.09/-0.09")

Novojunta® Pro AL30 RS Perimetral

REFERENCE	Joint width (a)	Visible width (b)	Profile height (h)	Horizontal movement	Vertical movement
NJPAL30RSPL	30 mm/1.18"	32.5 mm/1.27"	12.5 mm/0.49"	9,4 mm (+4,7/-4,7) 0.37" (+0.18/-0.18")	5 mm (+2.5/-2.5) 0.19" (+0.09/-0.09")

EMAC Complementos, S.L. reserves the right to make at any time modifications to the geometry profile or the specifications of its products.



EMAC COMPLEMENTOS, S.L. • Avda. Madrid 6 • 46930 Quart de Poblet, Valencia, Spain • Tel.: (+34) 961 532 200 - Fax: (+34) 961 532 261 • info@emac.es  
 EMAC ITALIA S.R.L. • Via Emilia-Romagna 104 • 41049 Sassuolo (Mo), Italia • Tel.: (+39) 0536994854 - Fax: (+39) 0536889025 • info@emac-italia.it  
 EMAC AMERICA, L.L.C. • 1970 NW 129 Avenue, Unit # 103 • Miami, FL 33182 • Phone: # (305) 406 1593 - Fax: (305) 406 1793 • info@emac-america.com

en.emac.es



Reg. 869888-2

# NOVOJUNTA® PRO MÓVIL

Model registered as community design No 869889-2

- Entirely made of aluminum expansion joint.
  - Great durability. Does not require maintenance.
  - Expansion joints in floorings (ceramics, concrete, terrace, stone...).
  - Striated non-slip surface
  - For joint widths up to 50 mm (1.96")
  - Movement allowed up to 10 mm (0.39")
  - It is delivered mounted with protective film
  - Easy and safe fixing with screws (not included)
- Consult the screw recommendation in the technical file.



## MATERIALS AND TECHNICAL DETAILS:

- Aluminum profiles drilled on the base for the fixing screws (not included)
- System of profiles with ability to absorb multidirectional movements
- Available in option firestop cords or membrane depending on the model (consult)
- Profiles delivered in 2.5 m. length (98.42")
- It is delivered mounted, with protective film

## AVAILABLE FINISHES



Natural



Silver matt anodized

Novojunta® Pro Móvil

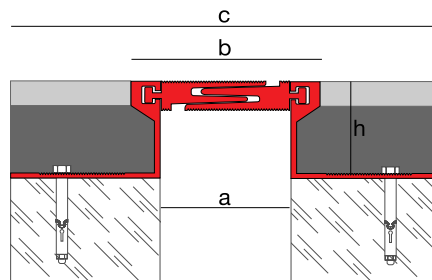

REFERENCE	Finish	Joint width (a)	Visible width (b)	Total width (c)	Profile height (h)	Horizontal movement
NJPMAL2071	Natural	50 mm / 1.96"	71 mm / 2.79"	154 mm / 6.06"	20 mm / 0.78"	10 mm (+5/-5) 0.39" (+0.19/-0.19")
NJPMAL3571	Natural				35 mm / 1.37"	
NJPMAL5071	Natural				50 mm / 1.96"	
NJPMAL7071	Natural				70 mm / 2.75"	

EMAC Complementos, S.L. reserves the right to make at any time modifications to the geometry profile or the specifications of his products.

# NOVOJUNTA® PRO METAL 30



- Entirely made of aluminum expansion joint.
- Great durability. Does not require maintenance.
- Expansion joints in floorings (ceramics, concrete, terrace, stone...).
- Supports heavy loads (trucks and forklifts..).
- Striated non-slip surface
- For joint widths up to 30 mm (1.18")
- Movement allowed up to 12 mm (0.47")
- Ideal for airports, malls, parkings...
- It is delivered pre-mounted with protective film.

## AVAILABLE FINISHES



Natural

## MATERIALS AND TECHNICAL DETAILS:

- Aluminum profiles drilled on the base for the fixing screws.
- System of profiles with ability to absorb multidirectional movements
- Available in option firestop cords or membrane depending on the model (consult)
- Profiles delivered in 2.5 m. length (98.4")
- It is delivered pre-mounted, with some special pieces that have to be removed once the installation is finished.
- Installation with fixing screws each 30 cm. (11.81") Recommended staggered distribution.
- The whole system includes all the fixing screws\*
- Delivered with protective film.

Novojunta® Pro Metal 30

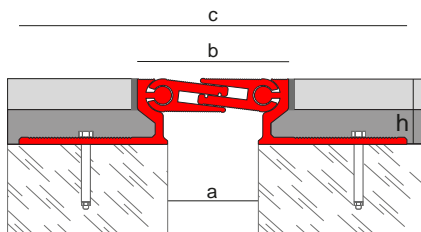

Novojunta® Pro Metal 30 Perimetral

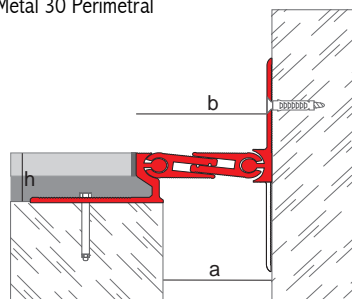

Download the EMAC® app from the App Store and Google Play



Novojunta® Pro Metal 30

REFERENCE	Joint width (a)	Visible width (b)	Total width (c)	Profile height (h)	Horizontal movement	Vertical movement
NJPM30AL22NA25	30 mm	50 mm	130 mm	22 mm	12 mm (+5/-7)	14 mm (+/-7)
NJPM30AL50NA25			166 mm	50 mm		

Novojunta® Pro Metal 30 Perimetral

REFERENCE	Joint width (a)	Visible width (b)	Profile height (h)	Horizontal movement	Vertical movement
NJPM30AL22PER	30 mm	50 mm	22 mm	12 mm (+5/-7)	14 mm (+/-7)
NJPM30AL50PER			50 mm		

\* Fixing screws included ref. FIJACION8X60 - 6 u/complete meter of joint



# NOVOJUNTA® PRO METAL 45

- Entirely made of aluminum expansion joint.
- Great durability. Does not require maintenance.
- Expansion joints in floorings (ceramics, concrete, terrace, stone...).
- Supports heavy loads (trucks, forklifts and shopping carts...).
- Striated non-slip surface
- Flat surface to avoid the accumulation of dirt
- For joint widths up to 45 mm (1,77")
- Movement allowed up to 20 mm (0.79")
- It is delivered pre-mounted with protective film.



## MATERIALS AND TECHNICAL DETAILS:

- Aluminum profiles drilled on the base for the fixing screws.
- System of profiles with ability to absorb multidirectional movements
- Available in option firestop cords or membrane depending on the model (consult)
- Profiles delivered in 2.5 m. length (98.4")
- It is delivered pre-mounted, with some special pieces that have to be removed once the installation is finished.
- Installation with fixing screws each 30 cm. (11.81") Recommended staggered distribution.
- The whole system includes all the fixing screws\*
- Delivered with protective film.

## AVAILABLE FINISHES:



Natural

Novojunta® Pro Metal 45

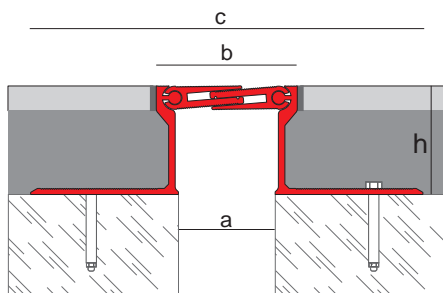

Novojunta® Pro Metal 45 Perimetral

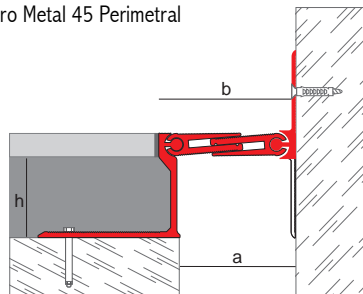

Download the EMAC® app from the App Store and Google Play



Novojunta® Pro Metal 45

REFERENCE	Joint width (a)	Visible width (b)	Total width (c)	Profile height (h)	Horizontal movement	Vertical movement
NJPM45AL22NA25	45 mm	65 mm	145 mm	22 mm	20 mm (+/-10)	20 mm (+/-10)
NJPM45AL50NA25			181 mm	50 mm		

Novojunta® Pro Metal 45 Perimetral

REFERENCE	Joint width (a)	Visible width (b)	Profile height (h)	Horizontal movement	Vertical movement
NJPM45AL22PER	45 mm	65 mm	22 mm	20 mm (+/-10)	20 mm (+/-10)
NJPM45AL50NPER			50 mm		

\* Fixing screws included ref. FIJACION8X60 - 6 u/complete meter of joint

# NOVOJUNTA® PRO METAL 50



\*21902015



- Entirely made of aluminum expansion joint.
- Great durability. Does not require maintenance.
- Expansion joints in floorings (ceramics, concrete, terrace, stone...).
- Supports heavy loads (trucks, forklifts and pallet trucks...).
- Striated non-slip surface.
- For joint widths up to 50 mm (1.96")
- Movement allowed up to 14 mm (0.55")
- Ideal for warehouses, airports, malls, parkings...
- It is delivered pre-mounted with protective film.

## AVAILABLE FINISHES



Natural

## MATERIALS AND TECHNICAL DETAILS:



\*21902015 (Inst. AIDIMME)  
Allows the traffic of vehicles with pneumatic wheels 300kN and forklifts and pallet trucks with rigid wheel until 9 kg/mm

- Aluminum profiles drilled on the base for the fixing screws.
- System of profiles with ability to absorb multidirectional movements
- Available in option firestop cords or membrane depending on the model (consult)
- Profiles delivered in 2.5 m. length (98.4")
- It is delivered pre-mounted, with some special pieces that have to be removed once the installation is finished.
- Installation with fixing screws each 30 cm. (11.81") Recommended staggered distribution.
- The whole system includes all the fixing screws\*
- Delivered with protective film.

Novojunta® Pro Metal 50

Novojunta® Pro Metal 50 Perimetral

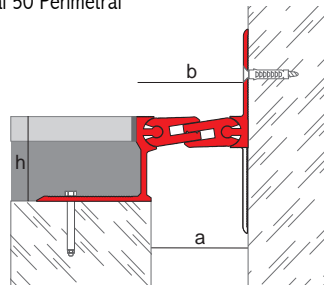
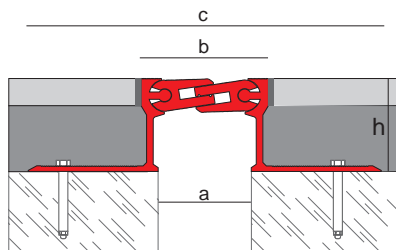

Download the EMAC® app from the App Store and Google Play



Novojunta® Pro Metal 50

REFERENCE	Joint width (a)	Visible width (b)	Total width (c)	Profile height (h)	Horizontal movement	Vertical movement
NJPM50AL22NA	50 mm	69 mm	190 mm	22 mm	14 mm (+6/-8)	24 mm (+/-12)
NJPM50AL35NA				35 mm		
NJPM50AL50NA				50 mm		
NJPM50AL80NA				80 mm		

Novojunta® Pro Metal 50 Perimetral

REFERENCE	Joint width (a)	Visible width (b)	Profile height (h)	Horizontal movement	Vertical movement
NJPM50AL22PER	50 mm	69 mm	22 mm	14 mm (+6/-8)	24 mm (+/-12)
NJPM50AL35PER			35 mm		
NJPM50AL50PER			50 mm		
NJPM50AL80PER			80 mm		

\* Fixing screws included ref. FIJACION8X60 - 6 u/complete meter of joint

EMAC Complementos, S.L. reserves the right to make at any time modifications to the geometry profile or the specifications of his products.



EMAC COMPLEMENTOS, S.L. • Avda. Madrid 6 • 46930 Quart de Poblet, Valencia, Spain • Tel.: (+34) 961 532 200 - Fax: (+34) 961 532 261 • info@emac.es  
EMAC ITALIA S.R.L. • Via Emilia-Romagna 104 • 41049 Sassuolo (Mo), Italia • Tel.: (+39) 0536994854 - Fax: (+39) 0536889025 • info@emac-italia.it  
EMAC AMERICA, L.L.C. • 1970 NW 129 Avenue, Unit # 103 • Miami, FL 33182 • Phone: # (305) 406 1593 - Fax: (305) 406 1793 • info@emac-america.com

en.emac.es



# NOVOJUNTA® PRO METAL 60

- Entirely made of aluminum expansion joint.
- Great durability. Does not require maintenance.
- Expansion joints in floorings (ceramics, concrete, terrace, stone...).
- Supports heavy loads (trucks, forklifts and pallet trucks...).
- Striated non-slip surface
- Flat surface to avoid the accumulation of dirt
- For joint widths up to 60 mm (2.36")
- Movement allowed up to 20 mm (0.79")
- It is delivered pre-mounted with protective film.

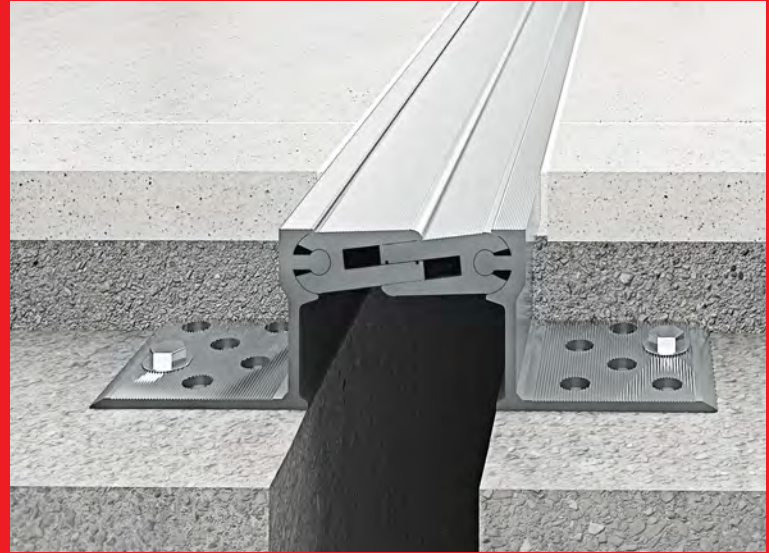

## MATERIALS AND TECHNICAL DETAILS:

- Aluminum profiles drilled on the base for the fixing screws.
- System of profiles with ability to absorb multidirectional movements
- Available in option firestop cords or membrane depending on the model (consult)
- Profiles delivered in 2.5 m. length (98.4")
- It is delivered pre-mounted, with some special pieces that have to be removed once the installation is finished.
- Installation with fixing screws each 30 cm. (11.81") Recommended staggered distribution.
- The whole system includes all the fixing screws\*
- Delivered with protective film.

## AVAILABLE FINISHES:



Natural

Novojunta® Pro Metal 60

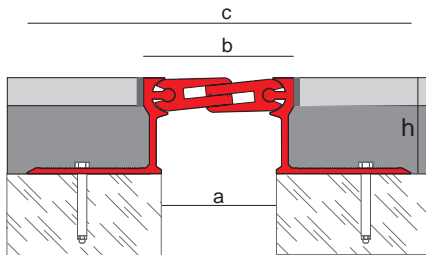

Novojunta® Pro Metal 60 Perimetral

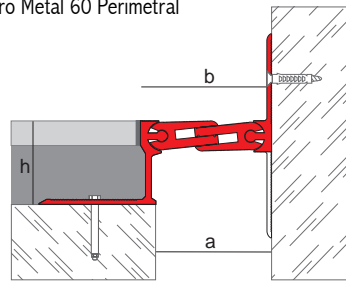

Download the EMAC® app from the App Store and Google Play



Novojunta® Pro Metal 60

REFERENCE	Joint width (a)	Visible width (b)	Total width (c)	Profile height (h)	Horizontal movement	Vertical movement
NJPM60AL18NA	60 mm	78 mm	200 mm	22 mm	20 mm (+9/-11)	30 mm (+15/-15)
NJPM60AL35NA				35 mm		
NJPM60AL50N3				50 mm		
NJPM60AL80NA				80 mm		

Novojunta® Pro Metal 60 Perimetral

REFERENCE	Joint width (a)	Visible width (b)	Profile height (h)	Horizontal movement	Vertical movement
NJPM60AL22PER	60 mm	78 mm	22 mm	20 mm (+9/-11)	30 mm (+15/-15)
NJPM60AL35PER			35 mm		
NJPM60AL50PER			50 mm		
NJPM60AL80PER			80 mm		

\* Fixing screws included ref. FIJACION8X60 - 6 u/complete meter of joint

# NOVOJUNTA® PRO METAL 80

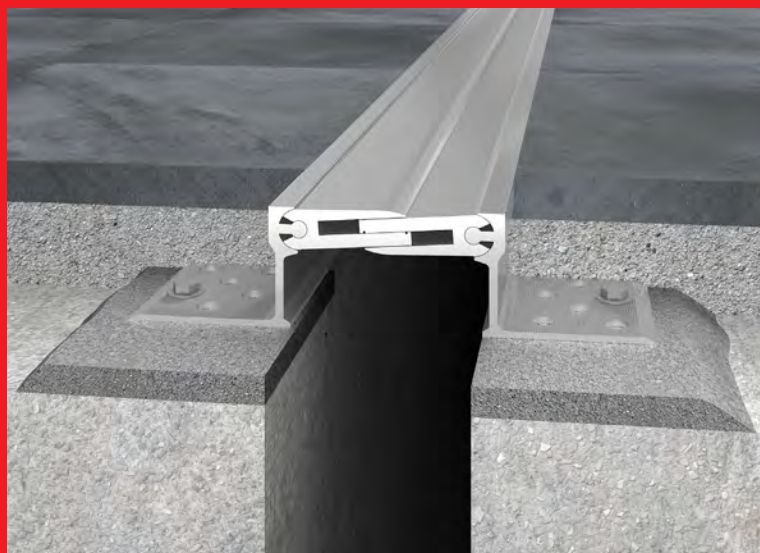

- Entirely made of aluminum expansion joint.
- Great durability. Does not require maintenance.
- Expansion joints in floorings (ceramics, concrete, terrace, stone...).
- Supports heavy loads (trucks, forklifts and pallet trucks...).
- Striated non-slip surface.
- For joint widths up to 80 mm (3.14")
- Movement allowed up to 32 mm (1.25")
- Ideal for warehouses, airports, malls, parkings...
- It is delivered pre-mounted with protective film.

## AVAILABLE FINISHES



Natural

## MATERIALS AND TECHNICAL DETAILS:

- Aluminum profiles drilled on the base for the fixing screws.
- System of profiles with ability to absorb multidirectional movements
- Available in option firestop cords or membrane depending on the model (consult)
- Profiles delivered in 2.5 m. length (98.4")
- It is delivered pre-mounted, with some special pieces that have to be removed once the installation is finished.
- Installation with fixing screws each 30 cm. (11.81") Recommended staggered distribution.
- The whole system includes all the fixing screws\*
- Delivered with protective film.

Novojunta® Pro Metal 80

Novojunta® Pro Metal 80 Perimetral

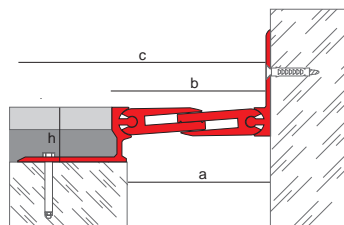
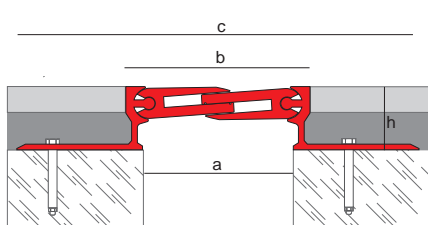

Download the EMAC® app from the App Store and Google Play



Novojunta® Pro Metal 80

REFERENCE	Joint width (a)	Visible width (b)	Total width (c)	Profile height (h)	Horizontal movement	Vertical movement	
NJPM80AL22NA	80 mm	97 mm	213 mm	22 mm	32 mm (+15/-17)	50 mm (+/-25)	
NJPM80AL35NA				35 mm			
NJPM80AL50NA			99 mm	220 mm			50 mm
NJPM80AL80NA							80 mm

Novojunta® Pro Metal 80 Perimetral

REFERENCE	Joint width (a)	Visible width (b)	Profile height (h)	Horizontal movement	Vertical movement
NJPM80AL22PER	88 mm	94 mm	22 mm	32 mm (+15/-17)	50 mm (+/-25)
NJPM80AL35PER			35 mm		
NJPM80AL50PER			50 mm		
NJPM80AL80PER			80 mm		

\* Fixing screws included ref. FIJACION8X60 - 6 u/completo meter of joint



# NOVOJUNTA® PRO METAL 100

- Entirely made of aluminum expansion joint.
- Great durability. Does not require maintenance.
- Expansion joints in floorings (ceramics, concrete, terrace, stone...).
- Supports heavy loads (trucks, forklifts and pallet trucks...).
- Striated non-slip surface
- Flat surface to avoid the accumulation of dirt
- For joint widths up to 100 mm (3.93")
- Movement allowed up to 20 mm (0.79")
- It is delivered pre-mounted with protective film.



## MATERIALS AND TECHNICAL DETAILS:

- Aluminum profiles drilled on the base for the fixing screws.
- System of profiles with ability to absorb multidirectional movements
- Available in option firestop cords or membrane depending on the model (consult)
- Profiles delivered in 2.5 m. length (98.4")
- It is delivered pre-mounted, with some special pieces that have to be removed once the installation is finished.
- Installation with fixing screws each 30 cm. (11.81") Recommended staggered distribution.
- The whole system includes all the fixing screws\*
- Delivered with protective film.

## AVAILABLE FINISHES:



Natural

Novojunta® Pro Metal 100

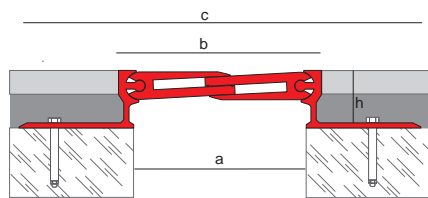

Novojunta® Pro Metal 100 Perimetral

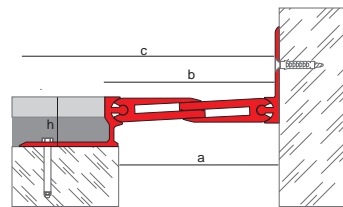

Download the EMAC® app from the App Store and Google Play



Novojunta® Pro Metal 100

REFERENCE	Joint width (a)	Visible width (b)	Total width (c)	Profile height (h)	Horizontal movement	Vertical movement
NJPM100AL22NA	100 mm	117 mm	223 mm	22 mm	43 mm (+23/-20)	50 mm (+/-25)
NJPM100AL35NA				35 mm		
NJPM100AL50NA		119 mm	240 mm	50 mm		
NJPM100AL80NA				80 mm		

Novojunta® Pro Metal 100 Perimetral

REFERENCE	Joint width (a)	Visible width (b)	Profile height (h)	Horizontal movement	Vertical movement
NJPM100AL22PER	108 mm	114 mm	22 mm	43 mm (+23/-20)	50 mm (+/-25)
NJPM100AL35PER			35 mm		
NJPM100AL50PER			50 mm		
NJPM100AL80PER			80 mm		

\* Fixing screws included ref. FIJACION8X60 - 6 u/complete meter of joint





# NOVOJUNTA® PRO METAL SIS110

- Great capacity of movement. Ideal for areas with seismic risk.
- For joint widths up to 110 mm (4.33")
- Movement allowed up to 40 mm (1.57")
- Entirely made of aluminum expansion joint.
- Great durability. Does not require maintenance.
- Expansion joints in floorings (ceramics, concrete, terrace, stone...).
- Support medium loads
- Striated non-slip surface



## MATERIALS AND TECHNICAL DETAILS:

- Aluminum profiles drilled on the base for the fixing screws.
- System of profiles with ability to absorb multidirectional movements
- Available in option firestop cords or membrane depending on the model (consult)
- Profiles delivered in 3 m. length (118.11")
- It is delivered pre-mounted, with some special pieces that have to be removed once the installation is finished, and with protective film.
- Installation with fixing screws each 30 cm (11.81")
- The whole system includes all the fixing screws\*

## AVAILABLE FINISHES:



Novojunta® Pro Metal SIS110

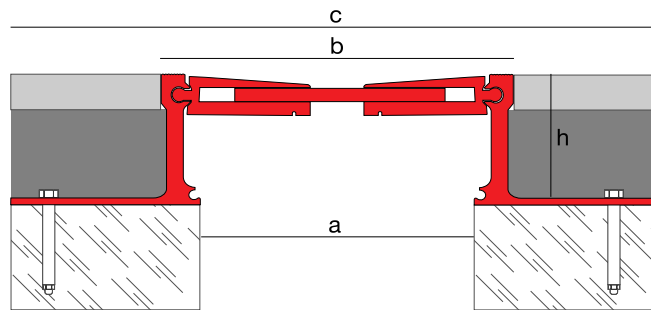

REFERENCE	Joint width (a)	Visible width (b)	Total width (c)	Profile height (h)	Horizontal movement	Vertical movement
NJPM110S18NA	110 mm/4.33"	130 mm/5.11"	220 mm/8.66"	18 mm/0.70"	40 mm (+20/-20) 1.57" (+0.78/-0.78")	20 mm (+10/-10) 0.78" (+0.39/-0.39")
NJPM110S35NA				35 mm/1.37"		
NJPM110S50NA				50 mm/1.96"		
NJPM110S80NA				80 mm/3.14"		

\* Fixing screws included ref. FIJACION8X60 - 6 u/complete meter of joint

EMAC Complementos, S.L. reserves the right to make at any time modifications to the geometry profile or the specifications of its products.

# NOVOJUNTA® PRO METAL SIS125

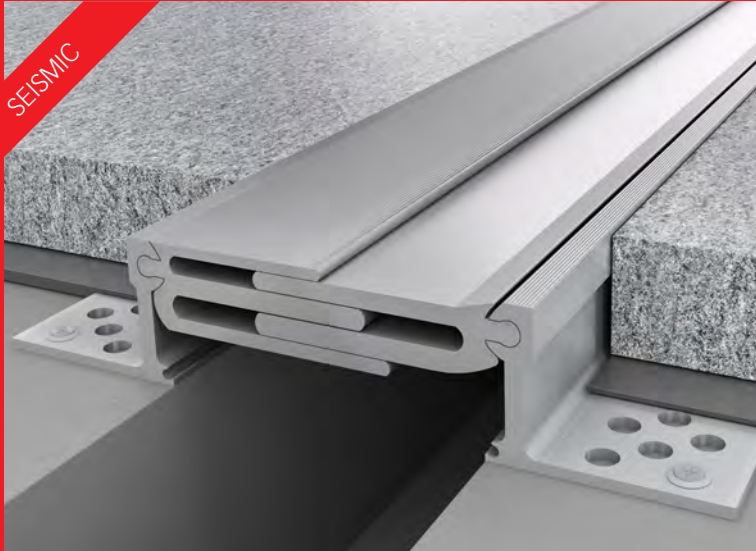

- Great capacity of movement. Ideal for areas with seismic risk.
- For joint widths up to 125 mm (4.92")
- Movement allowed up to 60 mm (2.36")
- Entirely made of aluminum expansion joint.
- Great durability. Does not require maintenance.
- Expansion joints in floorings (ceramics, concrete, terrace, stone...).
- Support extra heavy-duty loads (trucks, forklifts, pallet trucks with extra weight...)
- Striated non-slip surface

## AVAILABLE FINISHES



Natural

## MATERIALS AND TECHNICAL DETAILS:

- Aluminum profiles drilled on the base for the fixing screws.
- System of profiles with ability to absorb multidirectional movements
- Available in option firestop cords or membrane depending on the model (consult)
- Profiles delivered in 3 m. length (118.11")
- It is delivered pre-mounted, with some special pieces that have to be removed once the installation is finished, and with protective film.
- Installation with fixing screws each 30 cm. (11.81") Recommended staggered distribution.
- The whole system includes all the fixing screws\*

Novojunta® Pro Metal 125

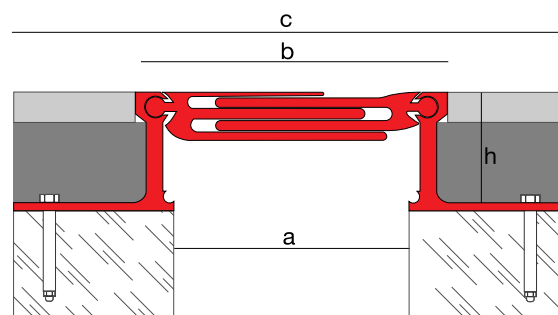

REFERENCE	Joint width (a)	Visible width (b)	Total width (c)	Profile height (h)	Horizontal movement	Vertical movement
NJPM125AL35N	125 mm/4.92"	140 mm/5.51"	260 mm/10.26"	35 mm/1.37"	60 mm (+30/-30) 2.36"(+1.18/-1.18")	20 mm (+10/-10) 0.78"(+0.39/-0.39")
NJPM125AL50N				50 mm/1.96"		
NJPM125AL80N				80 mm/3.14"		

\* Fixing screws included ref. FIJACION8X60 - 6 u/complete meter of joint



# NOVOJUNTA® PRO METAL SIS

- Great capacity of movement. Ideal for areas with seismic risk.
- For joint widths up to 200 mm (7.87")
- Movement allowed up to 60 mm (2.36")
- Entirely made of aluminum expansion joint.
- Great durability. Does not require maintenance.
- Expansion joints in floorings (ceramics, concrete, terrace, stone...).
- Support extra heavy-duty loads (trucks, forklifts, pallet trucks with extra weight...)
- Striated non-slip surface



## MATERIALS AND TECHNICAL DETAILS:

- The great capacity of movement is guaranteed by a double sliding hinge. The visible side is flat and without interruptions, to facilitate the transit.
- System of profiles with ability to absorb multidirectional movements
- Available in option firestop cords or membrane depending on the model (consult)
- Profiles delivered in 3 m. length (118.11")
- It is delivered mounted with protective film
- Installation with fixing screws each 30 cm (11.81")
- The whole system includes all the fixing screws\*
- The fixing of the system, 6 cm (2.36") from the edge of the profile, has been studied to preserve the adjacent flooring.

## AVAILABLE FINISHES



Novojunta® Pro Metal SIS

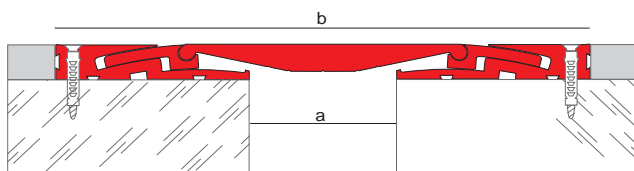

Angle version

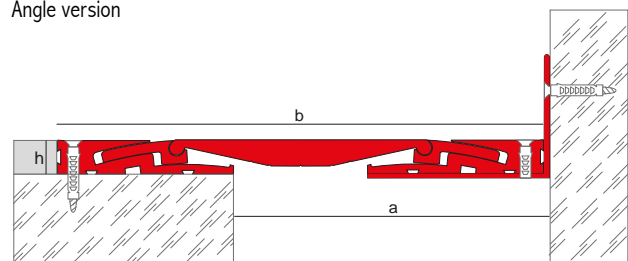

REFERENCE	Joint width (a)	Visible width (b)	Profile height (h)	Horizontal movement	Vertical movement
NJPMSIS50NA	50 mm/1.96"	255 mm/10.03"	20 mm/0.78"	60 mm (+30/-30) 2.36"(+1.18/-1.18")	50 mm (+25/-25) 1.96"(+0.98/-0.98")
NJPMSIS100NA	100 mm/3.93"	305 mm/12"			
NJPMSIS150NA	150 mm/5.90"	360 mm/14.17"			
NJPMSIS200NA	200 mm/7.87"	410 mm/16.14"			

\* Fixing screws included ref. kit TNJPMSIS - 1 u. kit/complete meter of joint . Screws suitable to fix the profile on a concrete base.

# NOVOJUNTA® PRO SISMO SU



- Ideal for areas with high seismic risk.
- Movement allowed up to 130 mm (5.11")
- For joint widths up to 100 mm (3.93")
- Entirely made of aluminum expansion joint.
- Great durability. Does not require maintenance.
- Expansion joints in floorings (ceramics, concrete, terrace, stone...).
- Installation con fixing screws (not included) . Consult screw recommendation in the technical file.
- Striated non-slip surface

## AVAILABLE FINISHES



Anodized Silver matt

## MATERIALS AND TECHNICAL DETAILS:

- Expansion joint consisting of sliding aluminum profiles in silver matt colour.
- System of profiles with ability to absorb multidirectional movements
- Available in option firestop cords or membrane depending on the model (consult)
- Profiles delivered in 2.5 m. length (98.42")
- It is delivered mounted, with protective film



See the video by capturing the QR code with your Smartphone or joining our corporate channel in Youtube (<http://www.youtube.com/user/emac complementos>).

Novojunta Pro® SISMO SU

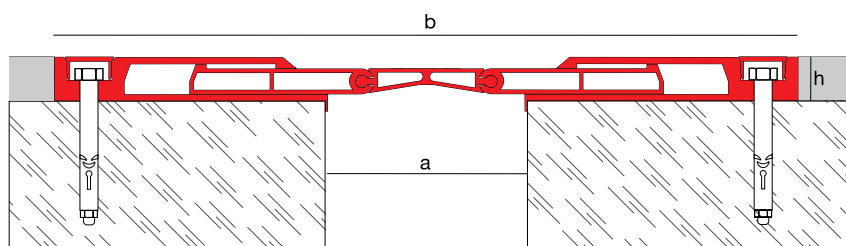

REFERENCE	Joint width (a)	Visible width (b)	Profile height (h)	Horizontal movement	Vertical movement
NIPSUALPL25	100 mm/3.93"	367,7 mm/14,47"	21,6 mm / 0.85"	130 mm (+65/-65) 5.11" (+2.55/-2.55")	12 mm / 0.47"



## 6. OVERLAPPED EXPANSION JOINTS



Our Technical Department (tecnico@emac.es) may assist you choosing the most appropriate profile ensuring the correct application fulfilling the CTE (Spanish Technical Building Code) and the recommendations included in the Norm UNE 138002:2017 (General Regulations for the execution of wall and floor tiles by adhesion).

# NOVOJUNTA® PRO BASIC SP



- Expansion joints in floorings (ceramics, concrete, terrace, stone...).
- For joint widths up to 40 mm (1.47")
- Movement allowed up to 14 mm (0.55").
- Replaceable rubber.
- Delivered unmounted

## MATERIALS AND TECHNICAL DETAILS:

- Aluminum profiles with "L" shape, drilled on the base for the fixing screws.
- High performance rubber insert with ability to absorb multidirectional movements. Excellent mechanical properties, great elasticity, good weatherability, UV and abrasion resistant, support thermal variations (-30°C / +120°C).
- Three rubber widths (20, 30 y 40 mm / 0.79", 1.18" and 1.57"), flat or striated.
- Available in option firestop cords
- Profiles delivered in 3 m (118.1") length
- The rubber insert is delivered separately
- The whole kit includes all the fixing screws\*\*

### RUBBER COLOUR



Black 9005



Grey 7035

#### SMOOTH



#### STRIATED

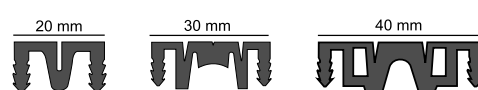

Novojunta® Pro Basic SP

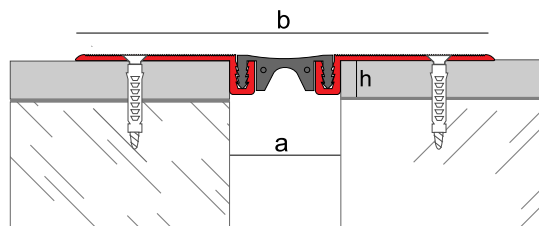

Download the EMAC® app from the App Store and Google Play



REFERENCE	Joint width (a)	Visible width (b)	Type of rubber (h)	Flat rubber movement	Striated rubber movement
NJPBS20*	20 mm (0.79")	124 mm (4.88")	flat or striated	8 mm (+4/-4) 0.31" (+0.15/-0.15)	10 mm (+5/-5) 0.39" (+0.19/-0.19)
NJPBS30*	30 mm (1.18")	134 mm (5.28")		10 mm (+5/-5) 0.39" (+0.19/-0.19)	12 mm (+6/-6) 0.47" (+0.23/-0.23)
NJPBS40*	40 mm (1.57")	144 mm (5.67")		12 mm (+6/-6) 0.47" (+0.23/-0.23)	14 mm (+7/-7) 0.55" (+0.27/-0.27)

\* Indicate the desired color and type (flat or striated) of rubber

\*\* Fixing screws included: screw ref. 04300 + plug ref. 046440 - 6 u/complete meter of joint

# NOVOJUNTA® PRO AL30

Model registered as community design No 1815762-0001



- Entirely made of aluminum expansion joint.
- Great durability. Does not require maintenance.
- Expansion joints in floorings (ceramics, concrete, terrace, stone...).
- For joint widths up to 30 mm. (1.18")
- Movement allowed up to 9.4 mm. (0.37")
- It is delivered mounted with protective film.
- Installation with screws (not included). Consult screw recommendation in the technical file.

## MATERIALS AND TECHNICAL DETAILS:

- Expansion joint consisting of sliding aluminum profiles.
- System of profiles with ability to absorb multidirectional movements
- Available in option firestop cords
- Profiles delivered in 2.5 m. length (98.4")
- It is delivered mounted, with protective film

## AVAILABLE FINISHES:



Silver matt anodized

Novojunta® Pro AL30 Superpuesta

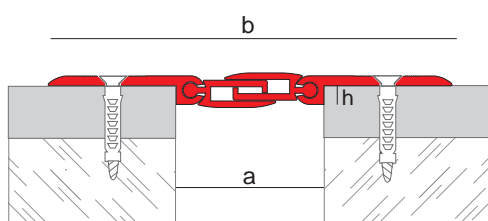

Novojunta® Pro AL30 Perimetral Superpuesta

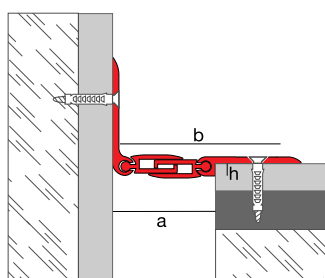

Download the EMAC® app from the App Store and Google Play



### Novojunta Pro® AL30

REFERENCE	Joint width (a)	Visible width (b)	Profile height (h)	Horizontal movement	Vertical movement
NIPAL30PL25	30 mm (1.18")	82 mm (3.29")	3.8 mm (0.15")	9.4 mm (+4.7/-4.7) 0.36" (+0.18/-0.18)	5 mm (+2.5/-2.5) 0.19" (+0.09/-0.09)

### Novojunta Pro® AL30 Perimetral

REFERENCE	Joint width (a)	Visible width (b)	Profile height (h)	Horizontal movement	Vertical movement
NIPPAL30PL	32 mm (1.26")	56 mm (2.21")	3.8 mm (0.15")	9.4 mm (+4.7/-4.7) 0.36" (+0.18/-0.18)	5 mm (+2.5/-2.5) 0.19" (+0.09/-0.09)





Reg. 869888-4



# NOVOJUNTA® PRO ANTIDESLIZANTE

Model registered as community design No 869891-4

- Expansion joints in floorings (ceramics, concrete, terrace, stone...).
- For joint widths up to 44 mm (1.73").
- Movement allowed up to 14 mm (0.55").
- Replaceable rubber.
- Striated non-slipping surface
- Installation with screws (not included). Consult screw recommendation in the technical file



## COLORS AND FINISHES

RUBBER:



Black 9005

PROFILES:



Natural



Silver matt anodized

## MATERIALS AND TECHNICAL DETAILS:

- Aluminum profiles with "L" shape, drilled on the base for the fixing screws.
- High performance rubber insert with ability to absorb multidirectional movements. Excellent mechanical properties, great elasticity, good weatherability, UV and abrasion resistant, support thermal variations (-30°C / +120°C).
- Available in option firestop cords
- Profiles delivered in 2.5 m length (98.4").
- It is delivered mounted, with protective film.

Novojunta® Pro Antideslizante

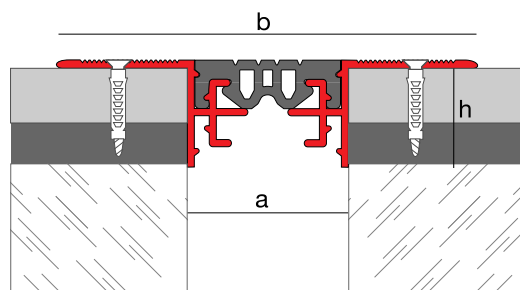

Download the EMAC® app from the App Store and Google Play



REFERENCE	Finish	Joint width(a)	Visible width(b)	Profile height(h)	Type of rubber	Horizontal movement
NJPADAL2087	Natural	34 mm (1.34")	87 mm (3.42")	20 mm (0.79")	estriada	10 mm (+5/-5) 0.39" (+0.19/-0.19)
NJPADAL2087PL	Silver matt anodized					
NJPADAL2097	Natural	44 mm (1.73")	97 mm (3.82")			14 mm (+7/-7) 0.55" (+0.27/-0.27)
NJPADAL2097PL	Silver matt anodized					

EMAC Complementos, S.L. reserves the right to make at any time modifications to the geometry profile or the specifications of its products.



EMAC COMPLEMENTOS, S.L. • Avda. Madrid 6 • 46930 Quart de Poblet, Valencia, Spain • Tel.: (+34) 961 532 200 - Fax: (+34) 961 532 261 • info@emac.es  
 EMAC ITALIA S.R.L. • Via Emilia-Romagna 104 • 41049 Sassuolo (Mo), Italia • Tel.: (+39) 0536994854 - Fax: (+39) 0536889025 • info@emac-italia.it  
 EMAC AMERICA, L.L.C. • 1970 NW 129 Avenue, Unit # 103 • Miami, FL 33182 • Phone: # (305) 406 1593 - Fax: (305) 406 1793 • info@emac-america.com

en.emac.es



Reg. 869888-3

# NOVOJUNTA® PRO DECOR

Model registered as community design No 869890-3



- Expansion joint for floors, walls and ceilings.
- For joint widths up to 30 mm (1.18") (depending on installation).
- Movement allowed up to 29,1 mm (1.14").
- Striated non-sliding surface.

## MATERIALS AND TECHNICAL DETAILS:

- Aluminum profiles
- Inside rubber with great capacity of movement
- Profiles delivered in 2.5 m length (98.4")
- It is delivered mounted with protective film on the visible side.
- Available in option firestop cords

## AVAILABLE FINISHES:



Natural



Anod. Silver matt

Novojunta® Pro Decor

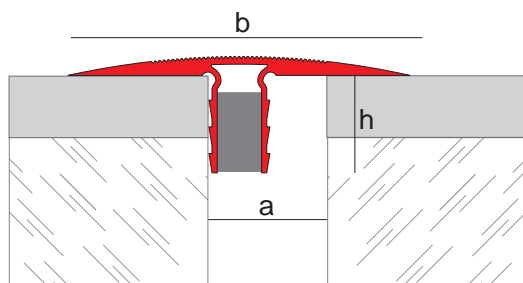

Download the EMAC® app from the App Store and Google Play



REFERENCE	Finishes	Joint width (a)	Visible width (b)	Profile height (h)	Horizontal movement
NJPDAL2070	Natural	12.6 mm (0.5")	70 mm (2.75")	20 mm (0.79")	3,4 mm (+1.7/-1.7) 0.13" (+0.06/-0.06)
NJPDAL2070PL	Silver matt anodized				
NJPDAL2070	Natural	30 mm (0.79")			29.1 mm (+19.1/-8) 1.14" (+0.74/-0.39)
NJPDAL2070PL	Silver matt anodized				

EMAC Complementos, S.L. reserves the right to make at any time modifications to the geometry profile or the specifications of his products.

# NOVOJUNTA® PRO SP

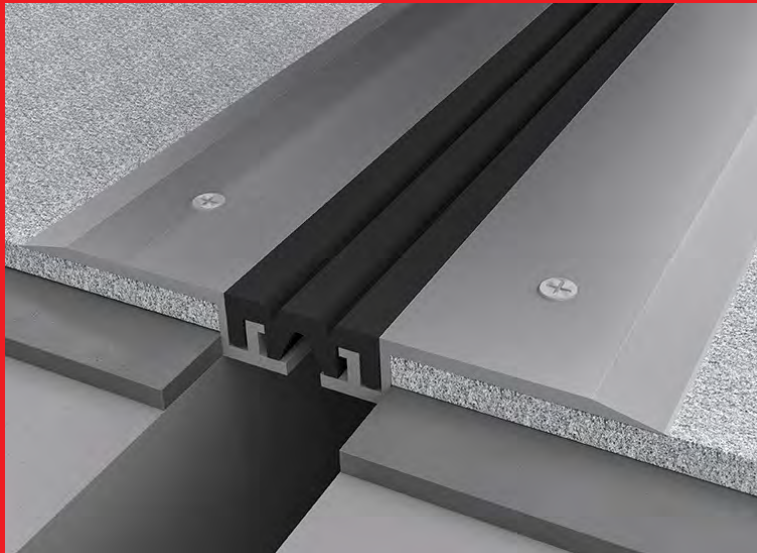

- Expansion joints in floorings (ceramics, concrete, terrace, stone...).
- For joint widths up to 50 mm (1.97").
- Movement allowed up to 14 mm (0.55").
- Replaceable rubber.
- Striated non-slipping surface
- Installation with screws (not included). Consult screw recommendation in the technical file

## RUBBER COLOUR



Black 9005



Grey 7035

## MATERIALS AND TECHNICAL DETAILS:

- Aluminum profiles with "L" shape, drilled for the fixing screws.
- High performance rubber insert with ability to absorb multidirectional movements. Excellent mechanical properties, great elasticity, good weatherability, UV and abrasion resistant, support thermal variations (-30°C / +120°C).
- Available in option firestop cords
- Profiles delivered in 3 m (118.1") length
- Striated rubber delivered in continuous rolls
- The whole kit includes the fixing screws\*

Novojunta® Pro SP

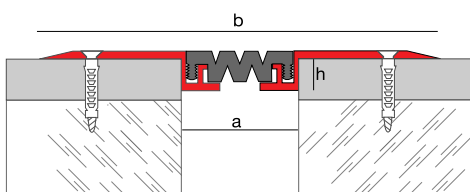

Angle version

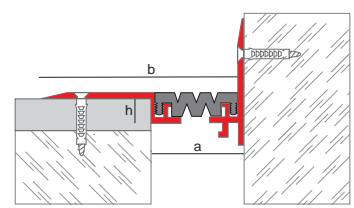
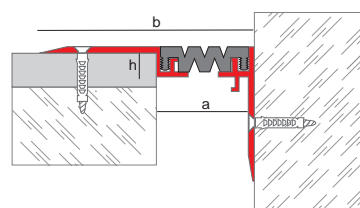

REFERENCE	Joint width(a)	Visible width(b)	Profile height(h)	Type of rubber	Horizontal movement
NJPSP35	35 mm (1.38")	145 mm (5.7")	13 mm (0.51")	estriada	14 mm (+7/-7) 0.55" (+0.27/-0.27)
NJPSP40	40 mm (1.57")	150 mm (5.90")			
NJPSP50	50 mm (1.97")	160 mm (6.3")			

\*\* Fixing screws included: screw ref. 04300 + plug ref. 046440 - 6 u/complete meter of joint



# NOVOJUNTA® PRO METAL SP50

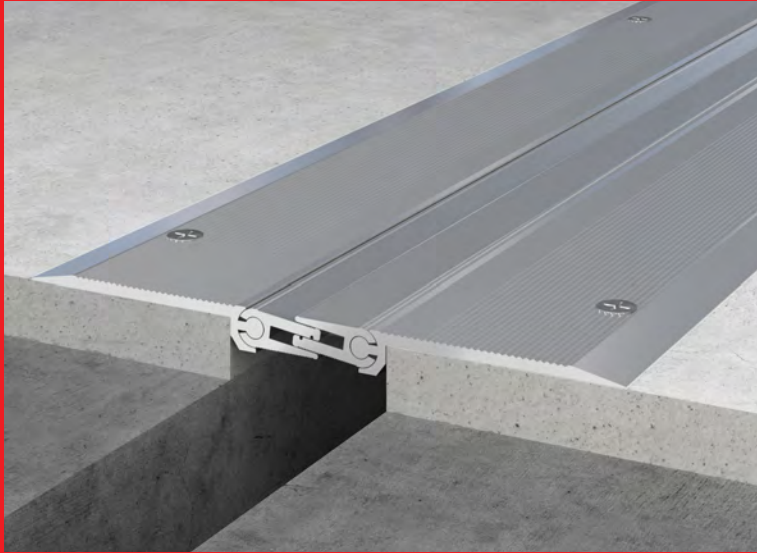

- Great movement capacity.
- Expansion joint entirely made of aluminum.
- Great durability. Does not require maintenance.
- Expansion joints in floorings (ceramics, concrete, terrace, stone...).
- Striated non-sliding surface.
- For joint widths up to 50 mm (1.97").
- Movement allowed up to 10 mm (0.39").
- Available perimeter version.

## MATERIALS AND TECHNICAL DETAILS:

- Expansion joint consisting of sliding aluminum profiles.
- System of profiles with ability to absorb multidirectional movements
- Good resistance of heavy loads and wear resistance.
- Profiles delivered in 2.5 m (98.4") length.
- It is delivered mounted, with protective film.
- The whole kit includes all the fixing screws\*\*
- Available perimeter version.
- Available in option firestop cords

## AVAILABLE FINISH



Natural

Novojunta® Pro Metal SP50

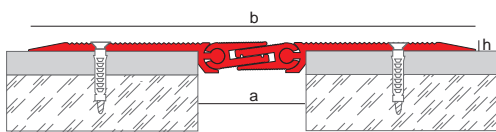

Novojunta® Pro Metal SP50 Péri-métral

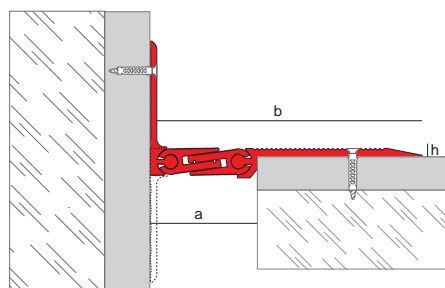

Download the EMAC® app from the App Store and Google Play



Novojunta® Pro Metal SP50

REFERENCE	Joint width(a)	Visible width(b)	Profile height(h)	Horizontal movement	Vertical movement
NJPMSP50NA	50 mm	190 mm	3,6 mm	10 mm (+3/-7)	10 mm (±5mm)

\* Fixings screws included ref. TNJPMSP50 system - 6 pcs system / lm

Novojunta® Pro Metal SP50 Perimeter

REFERENCE	Joint width(a)	Visible width(b)	Profile height(h)	Horizontal movement	Vertical movement
NJPMSP50NA	50 mm	117 mm	3,6 mm	10 mm (+3/-7)	10 mm (±5mm)

\* Fixings screws included ref. TNJPMSP50 system - 6 pcs system / lm

# NOVOJUNTA® PRO METAL SP 100

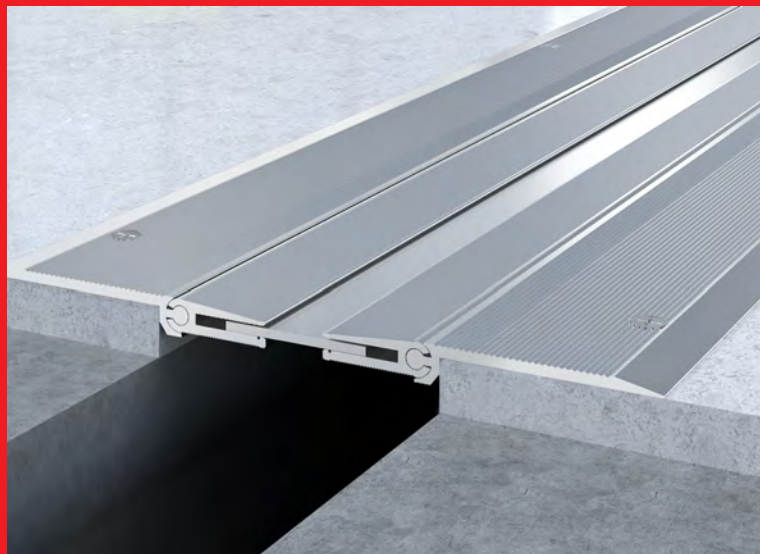

- Great movement capacity.
  - Expansion joint entirely made of aluminum.
  - Great durability. Does not require maintenance.
  - Expansion joints in floorings (ceramics, concrete, terrace, stone...).
- Striated non-sliding surface.
- For joint widths up to 100 mm (3.93").
  - Movement allowed up to 30 mm (1.18").
  - Available perimeter version.

## AVAILABLE FINISH



Natural

## MATERIALS AND TECHNICAL DETAILS:

- Expansion joint consisting of sliding aluminum profiles.
- System of profiles with ability to absorb multidirectional movements
- Good resistance of heavy loads and wear resistance.
- Profiles delivered in 2.5 m (98.4") length.
- It is delivered mounted, with protective film.
- The whole kit includes all the fixing screws\*\*
- Available perimeter version.
- Available in option firestop cords

Novojunta® Pro Metal SP100

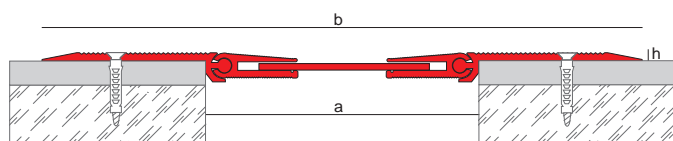

Novojunta® Pro Metal SP100 Perimetral

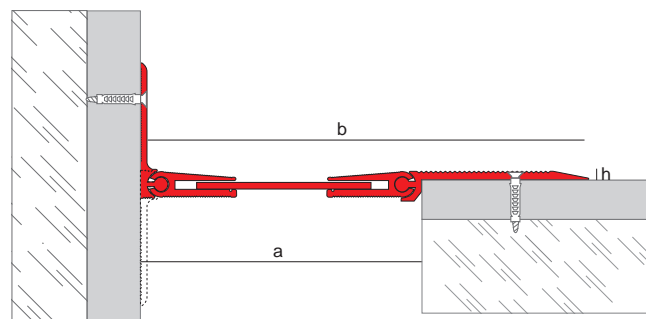

Novojunta® Pro Metal SP100

REFERENCE	Joint width(a)	Visible width(b)	Profile height(h)	Horizontal movement	Vertical movement
NIPMSP100NA	100 mm	240 mm	3.6 mm	30 mm (+20/-10)	16 mm (±8mm)

\* Fixings screws included ref. TNIPMSP50 system - 6 pcs system / lm

Novojunta® Pro Metal SP100 Perimetral

REFERENCE	Joint width(a)	Visible width(b)	Profile height(h)	Horizontal movement	Vertical movement
NIPMSP100NA	100 mm	170 mm	3.6 mm	30 mm (+20/-10)	16 mm (±8 mm)

\* Fixings screws included ref. TNIPMSP50 system - 6 pcs system / lm

# NOVOJUNTA® PRO SISMO PE

- Great movement capacity. Ideal for areas with seismic risk.
- Movement allowed up to 65 mm (2.55").
- For joint widths up to 74 mm (2.91").
- Expansion joint entirely made of aluminum.
- Great durability. Does not require maintenance.
- Expansion joint for perimeters and encounters between constructive elements
- Installation with fixing screws (not included). Consult screw recommendation in the technical file.



## AVAILABLE FINISHES



Silver matt anodized

## MATERIALS AND TECHNICAL DETAILS:

- Expansion joint consisting of sliding aluminum profiles in silver matt finish.
- Great capacity of movement.
- Profiles delivered in 2.5 m (98.4") length.
- It is delivered mounted, with protective film.
- Available in option firestop cords

Novojunta® ProSismo PE

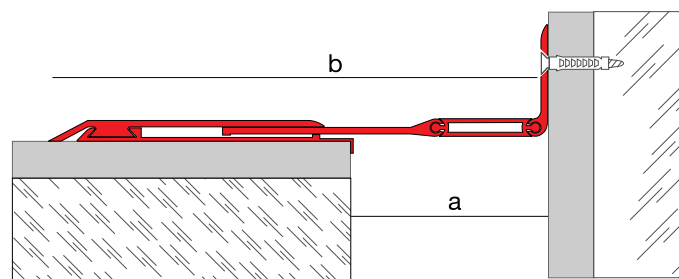

REFERENCE	Joint width(a)	Visible width(b)	Horizontal movement	Dilatación vertical
NIPPEALPL25	74 mm (2.91")	193.5 mm (7.62")	65 mm (+32.5/-32.5) 2.55" (+1.27/-1.27)	10 mm (+5/-5) 0.39" (+0.19/-0.19)



# 7. VERTICAL JOINTS



Our Technical Department (tecnico@emac.es) may assist you choosing the most appropriate profile ensuring the correct application fulfilling the CTE (Spanish Technical Building Code) and the recommendations included in the Norm UNE 138002:2017 (General Regulations for the execution of wall and floor tiles by adhesion).



# NOVOJUNTA® PRO PA

- Great capacity of movement. Ideal for areas with seismic risk.
- Horizontal movement up to 180 mm (7.09").
- For joint widths up to 390 mm (12.99").
- Vertical expansion joints (walls and facades) or horizontal ones (ceilings)
- Easy to install by using fixing screws.



## MATERIALS AND TECHNICAL DETAILS:

- Light aluminium profiles with "L" shape drilled on the base for the fixing screws.
- High performance rubber insert with ability to absorb multidirectional movements. Excellent mechanical properties, great elasticity, good weatherability, UV and abrasion resistant, support thermal variations (-30°C / +120°C).
- Rubber widths available 40, 85, 145, 190 y 320 mm (1.57", 3.35", 5.7", 7.48" and 12.6").
- Available in option firestop cords or membranes (depending on the model)
- Profiles delivered in 3 m length (118.1").
- Rubber delivered in continuous rolls
- The whole kit includes the fixing screws\*

## RUBBER COLOUR



Black 9005

Other colours on request

Novojunta® Pro PA

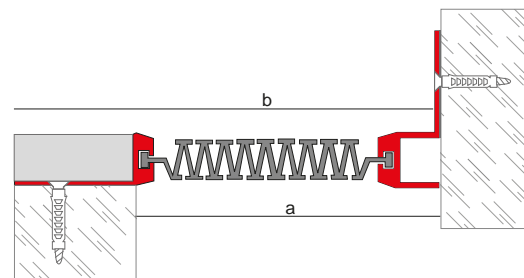
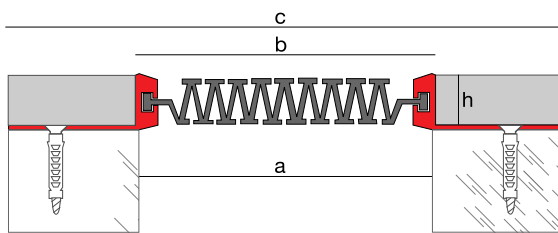

REFERENCE	Joint width (a)	Profile height (h)	Type of rubber	Minim. Joint Width	Maxm. Joint Width
NJPPA2050	20 a 40 mm (0.79"-1.57")	15 mm (0.59")	Striated	10 mm (0.39")	50 mm (1.97")
NJPPA50120	50 a 100 mm (1.97"-3.94")			25 mm (0.98")	110 mm (4.33")
NJPPA100160	80 a 150 mm (3.15"-5.91")			50 mm (1.97")	170 mm (6.69")
NJPPA120200	120 a 200 mm (4.72"-7.87")			80 mm (3.15")	220 mm (8.66")
NJPPA260390	170 a 300 mm (6.69"-11.81")			130 mm (5.12")	340 mm (13.39")

\* Fixing screws included ref. FIJAC8X60TG - 6 u/complete meter of joint

# NOVOJUNTA® PRO PASP



- Great capacity of movement. Ideal for areas with seismic risk.
- Horizontal movement up to 180 mm (7.09").
- For joint widths up to 360 mm (14.17").
- Vertical expansion joints (walls and facades) or horizontal ones (ceilings)
- Easy to install by using fixing screws.

## COLORES GOMAS



Black 9005

Other colours on request

## MATERIALS AND TECHNICAL DETAILS:

- Light aluminium profiles drilled for the fixing screws.
- High performance rubber insert with ability to absorb multidirectional movements. Excellent mechanical properties, great elasticity, good weatherability, UV and abrasion resistant, support thermal variations (-30°C / +120°C).
- Rubber widths available 40, 85, 145, 190 y 320 mm (1.57", 3.35", 5.7", 7.48" and 12.6").
- Available in option firestop cords or membranes (depending on the model)
- Profiles delivered in 3 m length (118.1").
- Rubber delivered in continuous rolls
- The whole kit includes the fixing screws\*

Novojunta® Pro PASP

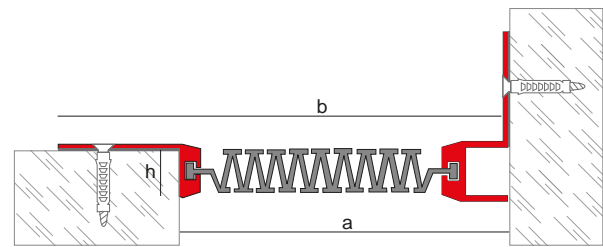
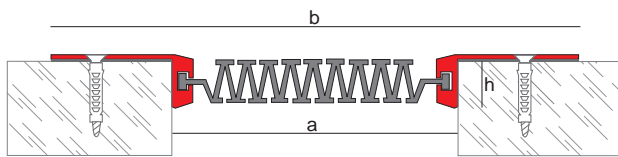

REFERENCE	Joint width (a)	Profile height (h)	Type of rubber	Minim. Joint Width	Maxm. Joint Width
NIPASP2060	20 a 50 mm (0.79"-1.97")	12 mm (0.47")	estriada	10 mm (0.39")	60 mm (3.36")
NIPASP50120	60 a 110 mm (3.36"-4.33")			35 mm (1.37")	120 mm (4.72")
NIPASP110180	90 a 150 mm (3.53"-5.91")			60 mm (2.36")	180 mm (1.97")
NIPASP120260	130 a 210 mm (5.12"-8.27")			90 mm (3.54")	240 mm (9.45")
NIPASP180410	180 a 310 mm (7.09"-12.20")			140 mm (5.51")	360 mm (14.17")

\* Fixing screws included: screw ref. 04300 + plug ref. 046440 - 6 u/complete meter of joint

# NOVOJUNTA® PRO SISMO PA

- Great movement capacity. Ideal for areas with seismic risk.
- Movement allowed up to 130 mm (5.11").
- For joint widths up to 100 mm (3.94").
- Expansion joint entirely made of aluminum.
- Great durability. Does not require maintenance.
- Vertical expansion joint(walls and facades) or horizontal expansion joint (ceilings)
- Installation with fixing screws (not included). Consult screw recommendation in the technical file.



## AVAILABLE FINISH



Matt silver anodized

## MATERIALS AND TECHNICAL DETAILS:

- Expansion joint consisting of sliding aluminum profiles in silver matt finish.
- Great capacity of multidirectional movements
- Profiles delivered in 2.5 m. length (98.4")
- It is delivered mounted, with protective film.
- Available in option firestop cords

Novojunta® Pro SISMO PA

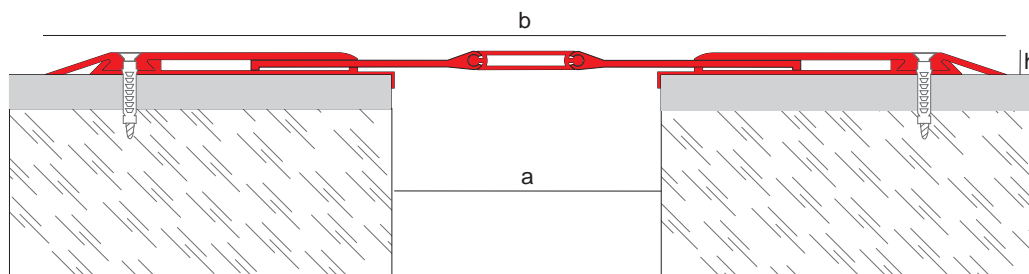

REFERENCE	Joint width(a)	Visible width (b)	Horizontal movement	Vertical movement
NIPPAALPL25	100 mm (3.94")	357.5 mm (14.07")	130 mm (+65/-65) 5.12" (+2.56/-2.56)	10 mm (+5/-5) 0.39" (+0.19/-0.19)

## 8. STRUCTURAL JOINTS SYSTEM COMPLEMENTS



Installed as part of the System or even separately, each of the elements comprising the Structural Joints System possesses certain technical benefits and characteristics that define it.

**1. Structural Joint Profile (Novojunta® Pro)**

**2. Novomembrana EPDM**

**3. Firestop cord**

# NOVOMEMBRANE EPDM

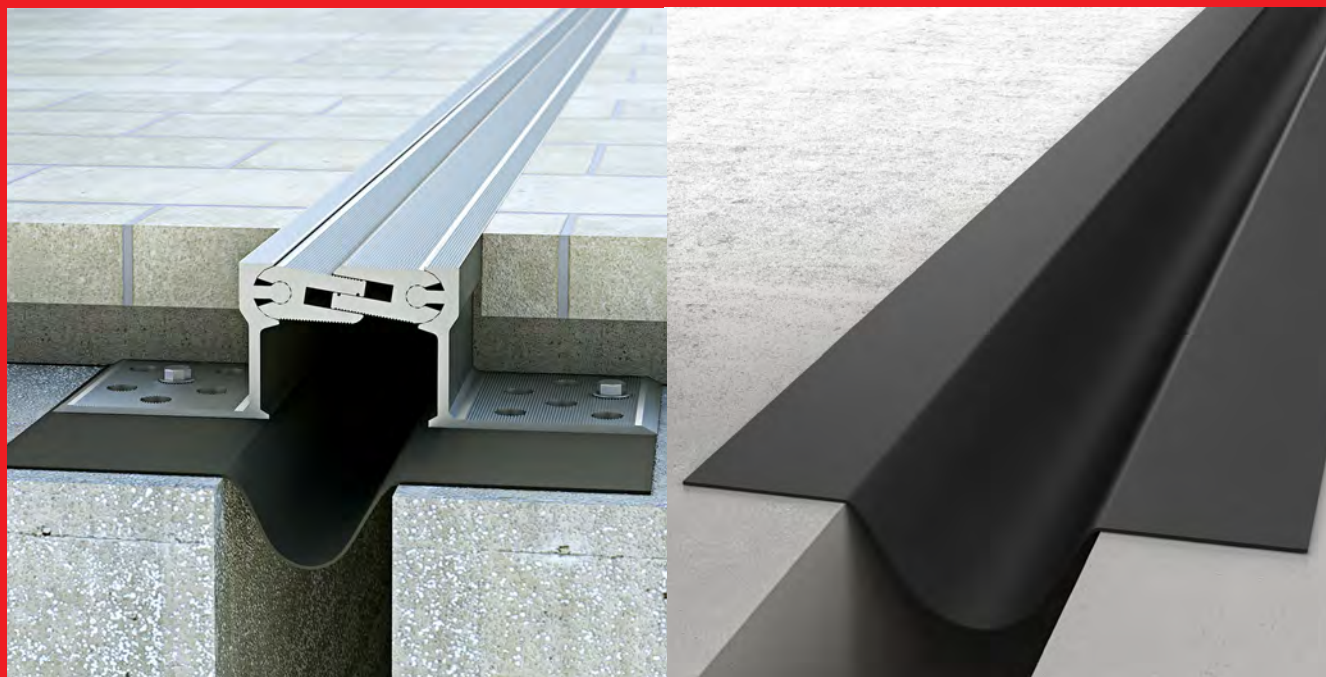

- Membrane made of high quality EPDM rubber with adhesive, designed to the expansion joints that require vapor barrier.
- It can be installed as a complement for expansion joint systems, or as an individual product.
- Great elasticity. Allow multi-directional movements.
- Waterproof material.
- Resistant to extreme temperatures (-30°C to +120°C), diluted acids or moderate concentrates, steam and hot water.
- Does not give off toxic smoke in the event of fire.
- Delivered in 1 lm or 20 lm rolls.

Novomembrana EPDM

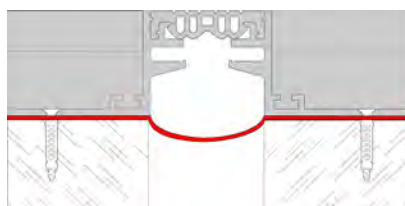

Guarda il video esplicativo scannerizzando questo codice QR con uno smartphone o accedendo al nostro canale aziendale su YouTube (<http://www.youtube.com/user/emaccomplementos>).

REFERENCE	Membrane width	Joint width	Color	Presentation
MEMEST140	140 mm (5.51")	Up to 40 mm (1.57")	black	Rolls of 20 lm.
MEMEST1401				Rolls of 1 lm.
MEMEST170	170 mm (6.69")	Up to 60 mm (2.36")	black	Rolls of 20 lm.
MEMEST1701				Rolls of 1 lm.
MEMEST200	200 mm (7.87")	Up to 80 mm (3.15")	black	Rolls of 20 lm.
MEMEST2001				Rolls of 1 lm.
MEMEST260	260 mm (10.24")	Up to 120 mm (4.72")	black	Rolls of 20 lm.
MEMEST2601				Rolls of 1 lm.

# FIRESTOP CORDS



- For standard and seismic joints in floors, walls and ceilings.
- Made of non combustible mineral fibers that do not rot, covered with a fiber glass net.
- Reaction to fire: Class M0 (fireproof).
- Fire resistance up to 240 minutes -without failure according to standars\*.
- Tested according to European Standards (SIST EN 13501-2:2016)
- Do not absorb moisture.
- Insusceptible to the most common chemical agents
- Easy to install with non combustible adhesive
- Do not contain asbestos.
- Chemically neutral, does not cause toxic smoke emission in case of fire.
- Working temperature : 780° C
- Melting temperature : 1200° C

REFERENCE	Joint width (Distance between slabs)	Cord diameter
NJCF30	16-20 mm (0.63-0.79")	30 mm (1.18")
NJCF40	21-30 mm (0.83-1.18")	40 mm (1.57")
NJCF50	31-40 mm (1.22-1.57")	50 mm (1.97")
NJCF60	41-50 mm (1.61-1.97")	60 mm (2.36")
NJCF70	51-60 mm (2-2.36")	70 mm (2.75")
NJCF90	61-80 mm (2.40-3.15")	90 mm (3.54")
NJCF120	91-100 mm (3.58-3.94")	120 mm (4.72")
NJCF150	110-130 mm (4.33-5.12")	150 mm (5.90")
NJCF180	150-160 mm (5.90-6.3")	180 mm (7.1")



\*EI 240 -V-X-F-W 10 to 150  
\*EI 240 -H-X-F-W 10 to 150

\*Fire resistance for 240 minutes – without failure



Guarda il video esplicativo scannerizzando questo codice QR con uno smar tphone o accedendo al nostro canale aziendale su YouTube (<http://www.youtube.com/user/emaccomplementos>).

## TABLA DE EQUIVALENCIAS SISTEMA PARA JUNTA ESTRUCTURAL

Ancho Junta	Novomembrana EPDM	Cordón Cortafuegos
20 mm (0.78")	MEMEST140	NJCF30
30 mm (1.18")	MEMEST170	NJCF40
40 mm (1.57")	MEMEST170	NJCF50
50 mm (1.97")	MEMEST200	NJCF60
60 mm (2.36")	MEMEST260	NJCF70
70 mm (2.75")	MEMEST260	NJCF90

Ancho junta	Novomembrana EPDM	Cordón Cortafuegos
80 mm (3.15")	MEMEST260	NJCF90
90 mm (3.54")	MEMEST260	NJCF120
100 mm (3.94")	MEMEST260	NJCF120
110 mm (4,33")	MEMEST260	NJCF150
120 mm (4.72")	MEMEST260	NJCF150
150 mm (5.90")	CONSULTAR	NJCF180

# 9. RETRACTING JOINTS IN CONCRETE FLOORS



# NOVOJUNTA® CONCRETE

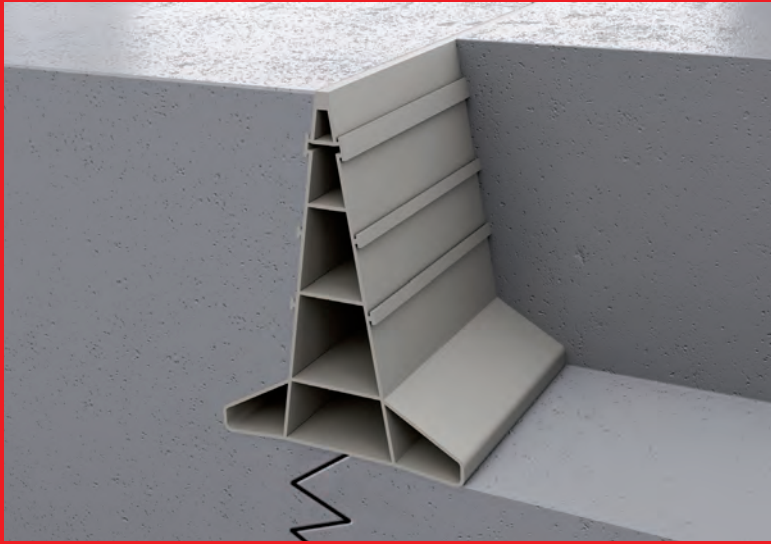

- Retracting joint for concrete floors to absorb the movements and prevent from cracking.
- It controls the expansion and retraction of the concrete in floors up to 24 cm (9.4") thick.
- Made of PVC. Available in heights of 40 mm (1.6") and 80 mm (3.15").
- Easy installation.
- It does not deteriorate over time.
- Once the work is finished, it is practically invisible.
- Perfect adherence.

## INSTALLATION

1. Attach the profiles with some dabs of concrete every 60-80 cm (25-30").
2. Level and finish attachment leaving the upper third closest to the vertex free.
3. Cut the intersections using a mitre block and hacksaw to ensure the vertices coincide perfectly.
4. Do not place dabs of concrete at the intersections. The closest must be 20-25 cm (8-10") away.
5. The profiles are simply joined by inserting a rod or corrugated wire into the gaps in the joints.
6. Concrete pouring: pour either traditionally or by pumping.
7. Straight-edging and floating: do the straight-edging manually and then use the concrete vibrator. This process avoids deterioration of the joint.
8. Finish: leave the joint vertex free for a perfect finish.

## MATERIALS AND TECHNICAL DETAILS

- Extruded PVC profile in cement grey colour.
- Approximate weight: 500 g/ml (80 mm / 3.15" model) and 250 g/ml (40 mm / 1.6" model).
- Profiles delivered in standard lengths of 2.5 m (98.4").
- Presentation in cardboard pallet boxes.

Novojunta® Hormigonado

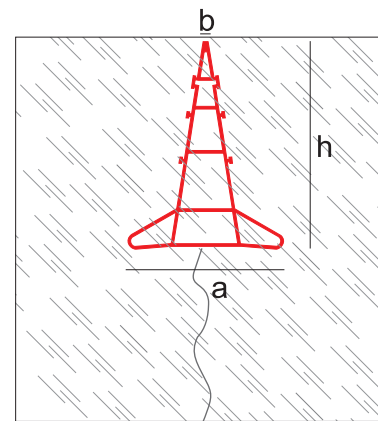

REFERENCE	Width (a)	Visible Width (b)	Profile height (h)	Packaging
NJHOR80GR25	60 mm (2.36")	2 mm (0.1")	80 mm (3.15")	20 bars
NJHOR40GR25	30 mm (1.18")		40 mm (1.57")	60 bars



# 10. COVER PLATES

# NOVOTAPAJUNTAS NDP



- It protects and embellishes the expansion joints on façades, walls and ceilings.
- Designed to cover joints from 10 to 130 mm wide (0.4"-5.12").
- Fast and easy to install thanks to its clip system, avoiding the use of adhesives and screws.
- Ideal for new constructions or rehabilitations.
- For indoors or outdoors.
- Ideal profile for all kind of projects: hospitals, malls, airports, hotels, residential buildings, etc.
- Made in PVC with anti-UV protection
- 4 profile models available width: 50, 70, 90 and 150 mm (2", 2.8", 3.5" and 5.9").
- Flat and angle models.
- Colours available: white (RAL 9016), beige (RAL 1015) and grey (RAL 7035).

## INSTALLATION

1. Insert a clip in the bottom rail
2. Change the direction of clips to insert one after another.
3. Lay the profile in front of the gap.
4. Insert it until the clips are fixed.

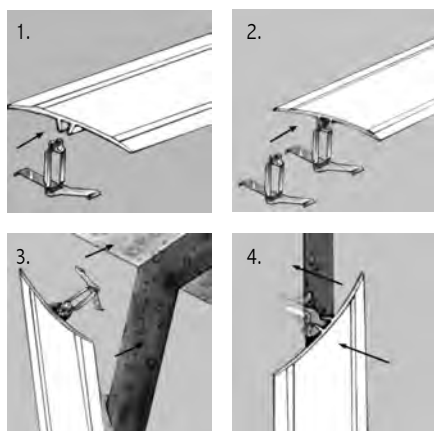

## MATERIALS AND TECHNICAL DETAILS

- Manufactured in PVC.
- The clips, manufactured in stainless steel, guarantee stable attachment yet permanent flexibility (spring effect). There are 4 models of clip available according to the width of joint to be covered.
- Profiles supplied in standard lengths of 3 m (118").
- The profile is supplied with the appropriate clip model and in the quantity required (5 clips for each 3-m / 118" profile).

Novotapajuntas NDP Flat

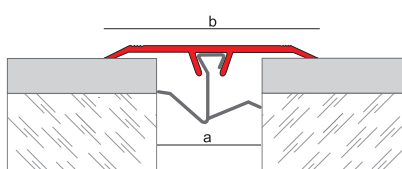

Novotapajuntas NDP Angle

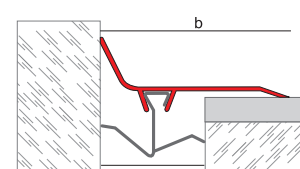

a: 10-35 mm  
(0.39-1.38")



S

a: 35-80 mm  
(1.38-3.15")



L

a: 60-110 mm  
(2.36-4.33")

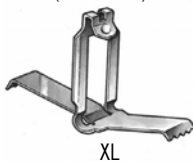

XL

a: 100-150 mm  
(3.94-5.91")

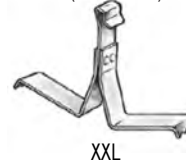

XXL

Download the EMAC® app from the App Store and Google Play



Type	Joint width(a)	Visible width (b)	Colours available	Model of clip	REFERENCE	Number of clips
Flat	Up to 35 mm (1.38")	50 mm (1.97")	White, Beige, Grey	S	NTDPP50*3	5
	Up to 50 mm (1.97")	70 mm (2.75")	White, Beige, Grey	S / L	NTDPP70*3	
	Up to 70 mm (2.75")	90 mm (3.54")	White	S / L / XL	NTDPP90BL	
	Up to 130 mm (5.12")	150 mm (5.90")	White	S / L / XL / XXL	NTDPP150BL	
Angle	Up to 35 mm (1.38")	50 mm (1.97")	White, Beige, Grey	S	NTDPP50*3	5
	Up to 50 mm (1.97")	70 mm (2.75")	White, Beige, Grey	S / L	NTDPP70*3	
	Up to 70 mm (2.75")	90 mm (3.54")	White	S / L / XL	NTDPP90BL	

\* Indicate the desired colour: White (BL), Beige (BE), Grey (GR)

# NOVOTAPAJUNTAS NDA

- It protects and embellishes the expansion joints on façades, walls, roofs and floors with light traffic.
- Designed to cover joints from 10 to 150 mm wide (0.4"-5.9").
- Fast and easy to install thanks to its clip system, avoiding the use of adhesives and screws.
- Ideal for new constructions or rehabilitations.
- For indoors or outdoors.
- Ideal profile for all kind of projects: hospitals, malls, airports, hotels, residential buildings, etc.
- Made of aluminium in silver matt anodized finish
- 7 profile models available for flat installation: 50, 70, 90, 120, 140, 180 and 210 mm (2", 2.8", 3.5", 4.7", 5.5", 7.1" and 8.3").
- 4 profile models available in angle version: 50, 70, 90 and 120 mm (2", 2.8", 3.5" and 4.7").



## MATERIALS AND TECHNICAL DETAILS

- Made of in anodized, extruded aluminium.
- The clips, made of stainless steel, guarantee stable attachment yet permanent flexibility (spring effect). There are 4 models of clips available according to the width of the expansion joint to be covered.
- Profiles supplied in standard lengths of 3 lm (118").
- The profile is delivered with the appropriate clip model and in the quantity required for installation.

## INSTALLATION

1. Insert a clip.
2. Change the direction of clips to insert one after another.
3. Prepared for installation.
4. Final placement.

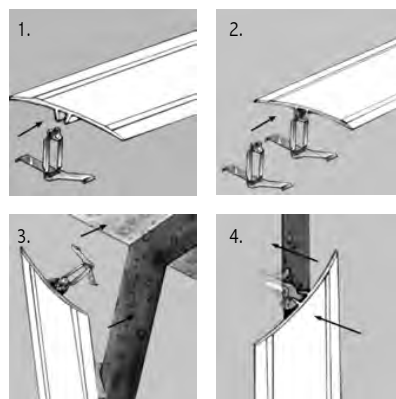

Novotapajuntas NDA Flat

Novotapajuntas NDA Angle

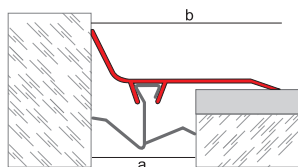
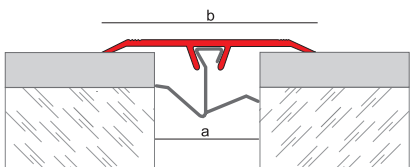

a: 10-35 mm  
(0.39-1.38")

a: 35-80 mm  
(1.38-3.15")

a: 60-110 mm  
(2.36-4.33")

a: 100-150 mm  
(3.94-5.91")

Download the EMAC® app from the App Store and Google Play

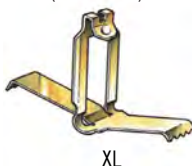

Type	Joint width (a)	Profile width(b)	Model of clip	REFERENCE	Number of clips
Flat	10 a 35 mm (0.39" to 1.38")	50 mm (1.97")	S	NTDAP50ALNA3	Walls: 4 u/profile
	35 a 50 mm (1.38" to 1.97")	70 mm (2.75")	S / L	NTDAP70ALNA3	
	40 a 70 mm (1.57" to 2.75")	90 mm (3.54")	L / XL	NTDAP90ALNA3	
	60 a 90 mm (2.36" to 3.54")	120 mm (4.72")	L / XL	NTDAP120ALN3	
	80 a 110 mm (3.15" to 4.33")	140 mm (5.51")	XL	NTDAP140ALN3	
	100 a 130 mm (3.94" to 5.12")	180 mm (7.09")	XL / XXL	NTDAP180ALN3	
	120 a 150 mm (4.72" to 5.90")	210 mm (8.27")	XXL	NTDAP210ALN3	
Angle	10 a 35 mm (0.39" to 1.38")	50 mm (1.97")	S	NTDAA50ALNA3	
	35 a 50 mm (1.38" to 1.97")	70 mm (2.75")	S / L	NTDAA70ALNA3	
	40 a 70 mm (1.57" to 2.75")	90 mm (3.54")	L / XL	NTDAA90ALNA3	
	60 a 90 mm (2.36" to 3.54")	120 mm (4.72")	L / XL	NTDAA120ALNA	



# NOVOTAPA JUNTAS GTA

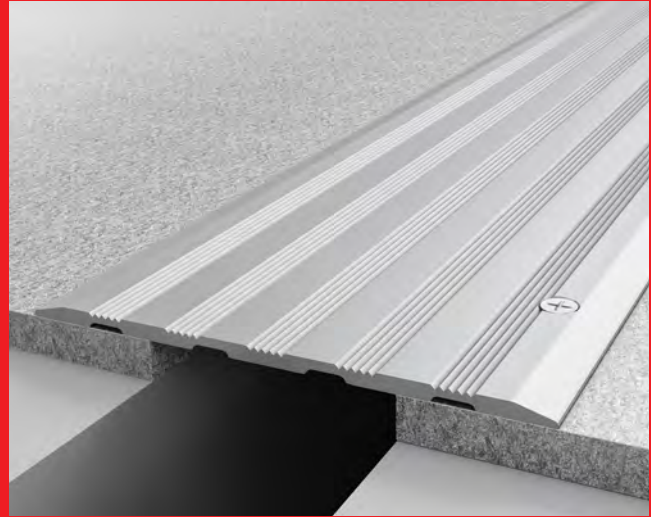
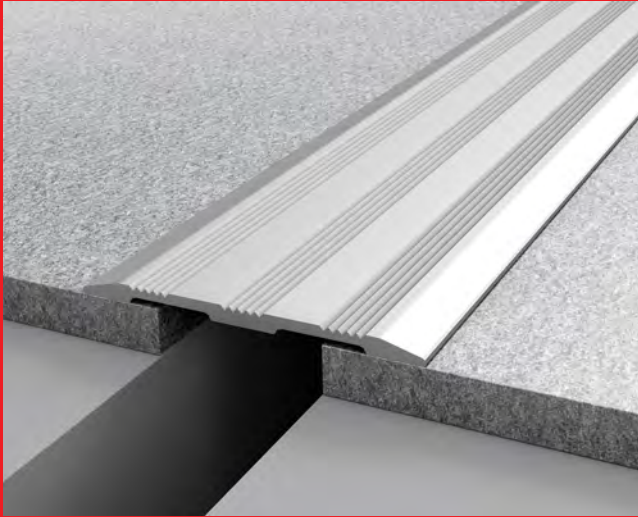

- This profile protects and embellishes the expansion joints on façades, walls, roofs and floors.
- Made of silver matt anodized aluminium (GTA 80 y GTA135) and naturel finition (GTA 180). Highly decorative.
- With non-slip striated visible side. It is an ideal profile for high-traffic areas such as hospitals, shopping centres, airports and hotels.
- Profiles supplied in standard lengths of 2.5 m (98.4”).
- The 80-mm (3.15”) model can also be supplied, on request, with incorporated adhesive for fast and easy installation, or with countersunk holes for the fixing screws (not included).
- The 135-mm (5.31”) model can also be supplied with countersunk holes for the fixing screws (not included) .
- The 180-mm (7.1”) model be supplied with countersunk holes for the fixing screws (not included)

GTA 80

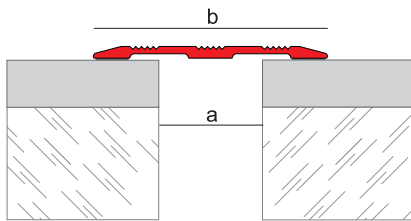

GTA 135

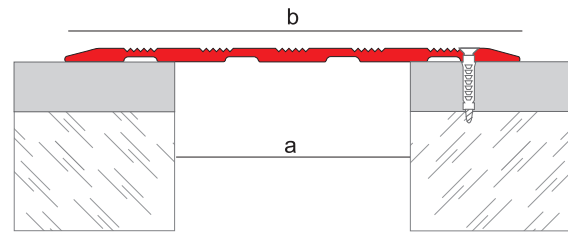

GTA 180

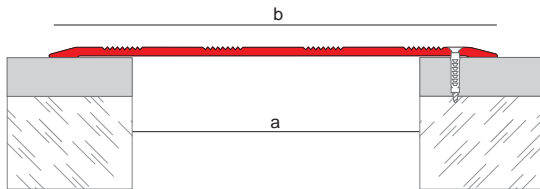

Download the EMAC® app from the App Store and Google Play



MODEL	Joint width (a)	Visible width (b)	Packaging	Type	REFERENCE
GTA80	Up to 30 mm (1.18")	80 mm (3.15")	10 u.	Without adhesive	NTGTAL80PL25
				With adhesive	NTGTAL80PLAD
				With holes	NTGTAL80PLA
GTA135	Up to 55 mm (2.16")	135 mm (5.31")	5 u.	Without holes	NTGTAL135PL
				With holes	NTGTAL135PLA
GTA180	Up to 100 mm (3.94")	180 mm (7.1")	5 ud.	With holes	NTGTAL180NA



# NOVOTAPAJUNTAS NCJE

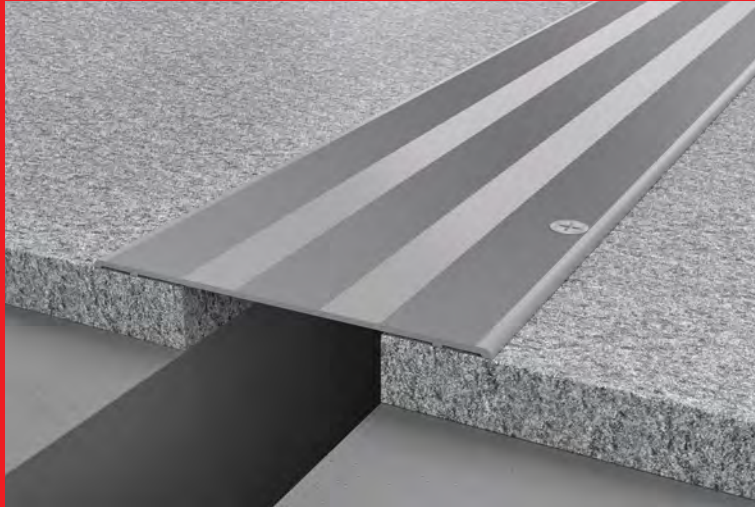

- Designed to cover the expansion joints on floors, walls, ceilings or façades.
- Manufactured in natural extruded aluminium.
- Visible face grooved anti-slip.
- Allows the transit of medium-load traffic.
- Profiles supplied in standard lengths of 3 m (118").
- Available in 4 sizes: 120, 180, 210 and 320 mm (4.7", 7.1", 8.3" and 12.6").
- Supplied with countersunk holes drilled in one side for screw installation (not included).

Joint width(a)	Visible width(b)	REFERENCE
Up to 130 mm (5.12")	210 mm (8.27")	NTCJE210ALNA
Up to 200 mm (7.87")	320 mm (12.6")	NTCJE320ALNA

Novotapajuntas NCJE

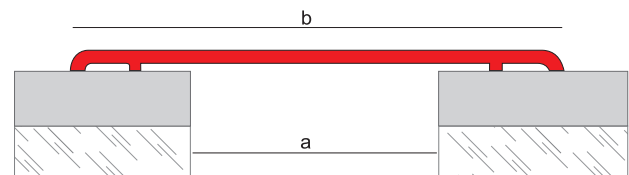

EMAC Complementos, S.L. reserves the right to make at any time modifications to the geometry profile or the specifications of its products.

# 11. MOVEMENT JOINTS FOR FLOORINGS



Our Technical Department (tecnico@emac.es) may assist you choosing the most appropriate profile ensuring the correct application fulfilling the CTE (Spanish Technical Building Code) and the recommendations included in the Norm UNE 138002:2017 (General Regulations for the execution of wall and floor tiles by adhesion).

# NOVOJUNTA® METALLIC



- Movement joint consisting of two aluminium profiles with a central body of EPDM micro-cellular rubber.
- Its main function is to prevent from cracking in floorings, absorbing the stresses (expansion and contraction) caused by thermal variations.
- Available for paving up to 125 mm (4.9") thick. For other thicknesses, ask us.
- Profiles delivered in standard lengths of 2.5 m (98.4").
- Supplied with protective film on the visible face.
- Available in black, grey and marble (up to 30 mm / 1.2" high). Also in brown, white and beige in the slimm model (4.5 mm / 0,18" height).

## GENERAL RECOMMENDATIONS FOR INSTALLATION

- For outdoor floorings, it is recommended closing regular areas up to 16 m<sup>2</sup> (172.22 ft<sup>2</sup>) maximum, with a distance between expansion joints not exceeding 2.5-5 lineal meters (98.42 - 196.85")
- For indoor floorings, with lower thermal change, it is recommended closing regular areas up to 40 m<sup>2</sup> (430.56 ft<sup>2</sup>) maximum, with a distance between expansion joints not exceeding 8 lineal meters (314.96")
- The particularities of each installation should be taken into account.

Novojunta® Metallic

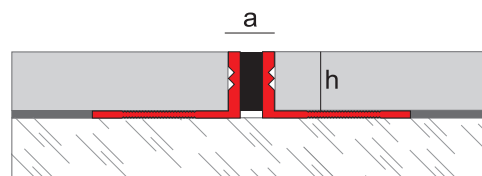

Profile height (h)	Visible width (a)	Horizontal movement	Packaging	Rubber Color	REFERENCE
4.5 mm (0.18")	6.4 mm (0.25")	4.5 mm (+0.5/-1.2) 0.18" (+0.01/-0.04)	20 u.	White	NIJAL04BL25
				Grey	NIJAL04GR25
				Beige	NIJAL04BE25
				Brown	NIJAL04MA25
				Black	NIJAL04NE25

6 mm (0.23")	8 mm (0.31")	3 mm (+1/-2) 0.12" (+0.04/-0.08)	20 u.	Grey	NIJAL06NA25
				Black	NIJAL06NE25
				Ivory	NIJAL06MF25
8 mm (0.31")	8 mm (0.31")	3 mm (+1/-2) 0.12" (+0.04/-0.08)	20 u.	Grey	NIJAL08NA25
				Black	NIJAL08NE25
				Ivory	NIJAL08MF25
10 mm (0.39")	8 mm (0.31")	3 mm (+1/-2) 0.12" (+0.04/-0.08)	20 u.	Grey	NIJAL10NA25
				Black	NIJAL10NE25
				Ivory	NIJAL10MF25
12.5 mm (0.49")	8 mm (0.31")	3 mm (+1/-2) 0.12" (+0.04/-0.08)	20 u.	Grey	NIJAL12NA25
				Black	NIJAL12NE25
				Ivory	NIJAL12MF25
15 mm (0.59")	8 mm (0.31")	3 mm (+1/-2) 0.12" (+0.04/-0.08)	20 u.	Grey	NIJAL15NA25
				Black	NIJAL15NE25
				Ivory	NIJAL15MF25

Profile height (h)	Visible width (a)	Horizontal movement	Packaging	Rubber Color	REFERENCE
17,5 mm (0.69")	8 mm (0.31")	3 mm (+1/-2) 0.12" (+0.04/-0.08)	20 u.	Grey	NJUAL17NA25
				Black	NJUAL17NE25
				Ivory	NJUAL17MF25
20 mm (0.79")	8 mm (0.31")	3 mm (+1/-2) 0.12" (+0.04/-0.08)	10 u.	Grey	NJUAL20NA25
				Black	NJUAL20NE25
				Ivory	NJUAL20MF25
22.5 mm (0.88")	8 mm (0.31")	3 mm (+1/-2) 0.12" (+0.04/-0.08)	10 u.	Grey	NJUAL22NA25
				Black	NJUAL22NE25
				Ivory	NJUAL22MF25
25 mm (0.98")	8 mm (0.31")	3 mm (+1/-2) 0.12" (+0.04/-0.08)	10 u.	Grey	NJUAL25NA25
				Black	NJUAL25NE25
				Ivory	NJUAL25MF25
27,5 mm (1.08")	8 mm (0.31")	3 mm (+1/-2) 0.12" (+0.04/-0.08)	10 u.	Grey	NJUAL27NA25
				Black	NJUAL27NE25
				Ivory	NJUAL27MF25
30 mm (1.18")	8 mm (0.31")	3 mm (+1/-2) 0.12" (+0.04/-0.08)	10 u.	Grey	NJUAL30NA25
				Black	NJUAL30NE25
				Ivory	NJUAL30MF25
41 mm (1.61")	11 mm (0.43")	4.7 mm (+1.2/-3.5) 0.18" (+0.05/-0.13)	10 u.	Black	NJUAL41NA25
51 mm (2.01")	11 mm (0.43")	4.7 mm (+1.2/-3.5) 0.18" (+0.05/-0.13)	10 u.	Black	NJUAL51NA25
125 mm (4.92")	11 mm (0.43")	4.7 mm (+1.2/-3.5) 0.18" (+0.05/-0.13)	4 u.	Black	NJUAL125NA25

## NOVOJUNTA® METALLIC PERIMETER

- Profile for perimeter expansion joints consisting of an aluminium profile with a body of EPDM micro-cellular rubber.
- Its main function is to prevent from cracking in floorings, absorbing the stresses (expansion and contraction) caused by thermal variations.
- Available for floorings up to 12 mm (0.47") thickness.
- Profiles delivered in standard lengths of 2.5 m (98.4").
- Supplied with protective film on the visible face.
- Available in black colour.



Novojunta® Metalic Perimetral

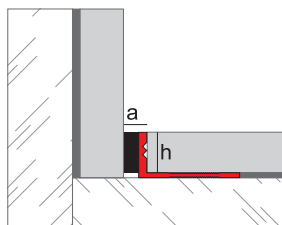

Profile height (h)	Visible width (a)	Horizontal movement	Packaging	Rubber Color	REFERENCE
10 mm (0.39")	6 mm (0.23")	3 mm (+1/-2) 0.12" (+0.04/-0.08)	20 u.	Black	NJUPAL10NA
12 mm (0.47")	6 mm (0.23")	3 mm (+1/-2) 0.12" (+0.04/-0.08)	20 u.	Black	NJUPAL12NA



# NOVOJUNTA® DECOR



- Movement joint consisting of two metal profiles with a central body of EPDM micro-cellular rubber.
- Available in stainless steel AISI-304, high brightness finish, or in silver matt anodized or natural aluminium.
- This movement joint is highly decorative, since it has a decorative plate on its visible face that masks the inner EPDM body.
- Its main function is to prevent from cracking in floorings, absorbing the stresses (expansion and contraction) caused by thermal variations.
- Available for floorings up to 126 mm (4.9") thickness. Other options on request.
- Profiles supplied in standard lengths of 2.5 m (98.4").
- Supplied with protective film on the visible face.

## GENERAL RECOMMENDATIONS FOR INSTALLATION

- For outdoor floorings, it is recommended closing regular areas up to 16 m<sup>2</sup> (172.22 ft<sup>2</sup>) maximum, with a distance between expansion joints not exceeding 2.5-5 lineal meters (98.42 - 196.85")
- For indoor floorings, with lower thermal change, it is recommended closing regular areas up to 40 m<sup>2</sup> (430.56 ft<sup>2</sup>) maximum, with a distance between expansion joints not exceeding 8 lineal meters (314.96")
- The particularities of each installation should be taken into account.

Novojunta® Decor Aluminium

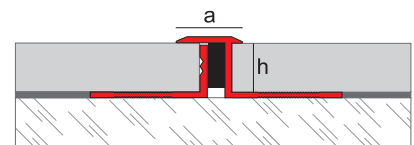

Novojunta® Decor Stainless steel

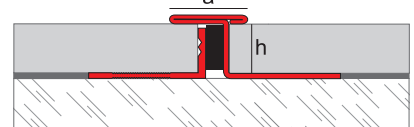

Material	Profile height* (h)	Visible width (a)	Horizontal movement	Packaging	Finish	REFERENCE
Aluminium	9,5 mm (0.37")	12.5 mm (0.49")	3 mm (+1/-2) 0.12" (+0.04/-0.08)	20 u.	Natural	NIDEAL10NA
					Matt silver anodized	NIDEAL10PL
	12 mm (0.47")	12.5 mm (0.49")	3 mm (+1/-2) 0.12" (+0.04/-0.08)	20 u.	Natural	NIDEAL12NA
					Matt silver anodized	NIDEAL12PL
	15 mm (0.59")	12.5 mm (0.49")	3 mm (+1/-2) 0.12" (+0.04/-0.08)	20 u.	Natural	NIDEAL15NA
					Matt silver anodized	NIDEAL15PL
	20 mm (0.79")	12.5 mm (0.49")	3 mm (+1/-2) 0.12" (+0.04/-0.08)	10 u.	Natural	NIDEAL20NA
				Matt silver anodized	NIDEAL20PL	
	41 mm (1.61")	12.5 mm (0.49")	4.7 mm (+1.2/-3.5) 0.18" (+0.05/-0.13)	10 u.	Natural	NIDEAL41NA
	51 mm (2")	12.5 mm (0.49")	4.7 mm (+1.2/-3.5) 0.18" (+0.05/-0.13)	10 u.	Natural	NIDEAL51NA
	126 mm (4.96")	12.5 mm (0.49")	4.7 mm (+1.2/-3.5) 0.18" (+0.05/-0.13)	4 u.	Natural	NIDEAL126NA
Stainless steel	10 mm (0.39")	12.5 mm (0.49")	3 mm (+1/-2) 0.12" (+0.04/-0.08)	20 u.	High brightness	NIDEAI10NA
	12 mm (0.47")	17 mm (0.67")	3 mm (+1/-2) 0.12" (+0.04/-0.08)	10 u.	High brightness	NIDEAI12NA
	15 mm (0.59")	17 mm (0.67")	3 mm (+1/-2) 0.12" (+0.04/-0.08)	10 u.	High brightness	NIDEAI15NA
	20 mm (0.79")	12.5 mm (0.49")	3 mm (+1/-2) 0.12" (+0.04/-0.08)	10 u.	High brightness	NIDEAI20NA
	41 mm (1.61")	10.8 mm (0.42")	4.7 mm (+1.2/-3.5) 0.18" (+0.05/-0.13)	10 u.	High brightness	NIDEAI41NA
	51 mm (2")	10.8 mm (0.42")	4.7 mm (+1.2/-3.5) 0.18" (+0.05/-0.13)	10 u.	High brightness	NIDEAI51NA
	126 mm (4.96")	10.8 mm (0.42")	4.7 mm (+1.2/-3.5) 0.18" (+0.05/-0.13)	4 u.	High brightness	NIDEAI126NA

\* Possibility of other heights on request



## NOVOJUNTA® DECOR XL

- Movement joint consisting of two aluminium profiles with a central body of EPDM micro-cellular rubber.
- This movement joint is highly decorative, since it has a silver matt cover plate that masks the inner EPDM body.
- Its main function is to prevent from cracking in floorings, absorbing the stresses (expansion and contraction) caused by thermal variations.
- The central EPDM micro-cellular rubber body, 20 mm (0.79") width, allows a great capacity of movement.
- Due to its movement capacity, is also recommended installed in façades.
- Profiles delivered in standard lengths of 2.5 m (98.4").
- Delivered with protective film on the visible face.



Novojunta® Decor XL

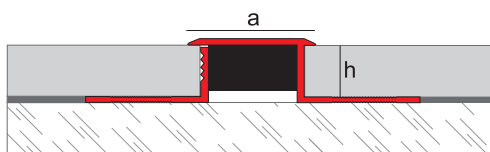

### GENERAL RECOMMENDATIONS FOR INSTALLATION

- For outdoor floorings, it is recommended closing regular areas up to 16 m<sup>2</sup> (172.22 ft<sup>2</sup>) maximum, with a distance between expansion joints not exceeding 2.5-5 lineal meters (98.42 - 196.85")
- For indoor floorings, with lower thermal change, it is recommended closing regular areas up to 40 m<sup>2</sup> (430.56 ft<sup>2</sup>) maximum, with a distance between expansion joints not exceeding 8 lineal meters (314.96")
- The particularities of each installation should be taken into account.

Profile height (h)	Visible width (a)	Horizontal movement	Packaging	Finish	REFERENCE
12 mm (0.47")	28 mm (1.10")	12 mm (+2/-10) 0.47" (+0.08/-0.39)	10 u.	Anodised matt silver	NJDEXLAL12PL



## NOVOJUNTA® METALLIC FLEX

- Solution for expansion joints in floors, walls or ceilings which consists of two aluminum sides with a central body made of high quality silicone rubber.
- This profile is perfect to absorb the thermal movements in floors and walls, and prevent from possible pathologies.
- Available in black or grey color. Possibility of custom made colors on request (with minimum order).
- Profiles supplied in standard lengths of 2.5 m (98.4").



Profile height (h)	Visible width (a)	Horizontal movement	Packaging	Finish	Silicone colour**	REFERENCE
10 mm (0.39")	16 mm (0.63")	5 mm (-3/+2) 0.20 " (+0.118/-0.118)	24 u.	Aluminium natural	Black o Grey	NJMF10*
12 mm (0.47")						NJMF12*
15 mm (0.5")						NJMF15*

\*Indicate desired rubber color. \*\*Possibility of custom made colors on request (minimum quantity)

# NOVOJUNTA® METALLIC FLECHA



- Arrow-shaped movement joint, designed to be installed with high thickness floorings
- It consists of two natural aluminium profiles and a central body of EPDM micro-cellular rubber, with an excellent capacity for absorbing the contractions and expansions of the flooring.
- We recommend installing it slightly below the level of the flooring, to enable the floor to be polished.
- Profiles supplied in standard lengths of 2.5 m (98.4").
- Supplied with protective film on the visible face.

## GENERAL RECOMMENDATIONS FOR INSTALLATION

- For outdoor floorings, it is recommended closing regular areas up to 16 m<sup>2</sup> (172.22 ft<sup>2</sup>) maximum, with a distance between expansion joints not exceeding 2.5-5 lineal meters (98.42 - 196.85")
- For indoor floorings, with lower thermal change, it is recommended closing regular areas up to 40 m<sup>2</sup> (430.56 ft<sup>2</sup>) maximum, with a distance between expansion joints not exceeding 8 lineal meters (314.96")
- The particularities of each installation should be taken into account.

Novojunta® Metallic flecha

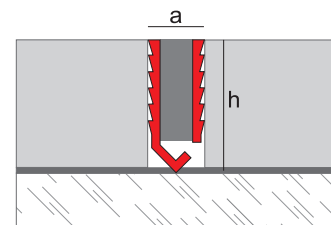

Profile height (h)	Visible width (a)	Finish	Horizontal movement	Packaging	REFERENCE
26 mm (1.02")	11 mm (0.43")	Natural + Grey rubber	4.7 mm (+1.2/-3.5) 0.18" (+0.05/-0.13)	30 u.	NJFAL26NA
35 mm (1.38")				30 u.	NJFAL35NA
50 mm (1.97")				20 u.	NJFAL50NA
65 mm (2.56")				10 u.	NJFAL65NA
85 mm (3.35")				10 u.	NJFAL85NA
125 mm (4.92")				5 u.	NJFAL125NA



Reg. 155585-F



# NOVOJUNTA® DECOR FLECHA

- Arrow-shaped movement joint, designed to be installed with high thickness floorings
- It consists of two natural aluminium profiles and a central body of EPDM micro-cellular rubber, with an excellent capacity for absorbing the contractions and expansions of the flooring.
- Available in stainless steel, high brightness finish, or in silver matt anodized or natural aluminium.
- This movement joint is highly decorative, since it has a decorative plate that masks the inner EPDM body.
- We recommend installing it slightly below the level of the paving, to enable the floor to be polished.
- Profiles delivered in standard lengths of 2.5 m (98.4").
- Supplied with protective film on the visible face.



Novojunta® Decor flecha

Aluminium

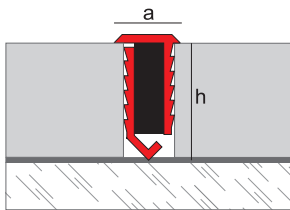

Stainless steel

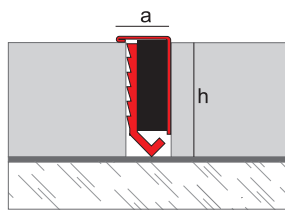

## GENERAL RECOMMENDATIONS FOR INSTALLATION

- For outdoor floorings, it is recommended closing regular areas up to 16 m<sup>2</sup> (172.22 ft<sup>2</sup>) maximum, with a distance between expansion joints not exceeding 2.5-5 lineal meters (98.42 - 196.85")
- For indoor floorings, with lower thermal change, it is recommended closing regular areas up to 40 m<sup>2</sup> (430.56 ft<sup>2</sup>) maximum, with a distance between expansion joints not exceeding 8 lineal meters (314.96")
- The particularities of each installation should be taken into account.

Material	Profile height(h)	Visible width (a)	Horizontal movement	Packaging	Finish	REFERENCE
Aluminium	30 mm (1.18")	12.5 mm (0.49")	4.7 mm (+1.2/-3.5) 0.18" (+0.05/-0.13)	30 u.	Natural	NJDFAL30NA
					Silver matt anodized	NJDFAL30PL
	35 mm (1.38")	12.5 mm (0.49")	4.7 mm (+1.2/-3.5) 0.18" (+0.05/-0.13)	30 u.	Natural	NJDFAL35NA
					Silver matt anodized	NJDFAL35PL
	50 mm (1.97")	12.5 mm (0.49")	4.7 mm (+1.2/-3.5) 0.18" (+0.05/-0.13)	30 u.	Natural	NJDFAL50NA
					Silver matt anodized	NJDFAL50PL
	65 mm (2.56")	12.5 mm (0.49")	4.7 mm (+1.2/-3.5) 0.18" (+0.05/-0.13)	10 u.	Natural	NJDFAL65NA
					Silver matt anodized	NJDFAL65PL
85 mm (3.35")	12.5 mm (0.49")	4.7 mm (+1.2/-3.5) 0.18" (+0.05/-0.13)	10 u.	Natural	NJDFAL85NA	
				Silver matt anodized	NJDFAL85PL	
125 mm (4.92")	12.5 mm (0.49")	4.7 mm (+1.2/-3.5) 0.18" (+0.05/-0.13)	5 u.	Natural	NJDFAL125NA	
				Silver matt anodized	NJDFAL125PL	
Stainless steel	30 mm (1.18")	10.8 mm (0.42")	4.7 mm (+1.2/-3.5) 0.18" (+0.05/-0.13)	30 u.	High brightness	NJDFAI30NA
	35 mm (1.38")	10.8 mm (0.42")	4.7 mm (+1.2/-3.5) 0.18" (+0.05/-0.13)	30 u.	High brightness	NJDFAI35NA
	50 mm (1.97")	10.8 mm (0.42")	4.7 mm (+1.2/-3.5) 0.18" (+0.05/-0.13)	30 u.	High brightness	NJDFAI50NA

# NOVOJUNTA® 1 PVC



- Movement joint with arrow shape made of co-extruded PVC. Consists of one rigid PVC part that efficiently protects the flooring edges, and another flexible PVC part that enables surface tensions to be absorbed.
- It consists of two natural aluminium profiles and a central body of EPDM micro-cellular rubber, with an excellent capacity for absorbing the contractions and expansions of the flooring.
- Suitable to support all kind of traffic.
- Available in up to 6 colours: white, grey, beige, brown, black and transparent.
- Profiles delivered in standard lengths of 2.5 m (98.4").
- If the floor will be polished, we recommend installing it slightly below the pavement level..

## GENERAL RECOMMENDATIONS FOR INSTALLATION

- For outdoor floorings, it is recommended closing regular areas up to 16 m<sup>2</sup> (172.22 ft<sup>2</sup>) maximum, with a distance between expansion joints not exceeding 2.5-5 lineal meters (98.42 - 196.85")
- For indoor floorings, with lower thermal change, it is recommended closing regular areas up to 40 m<sup>2</sup> (430.56 ft<sup>2</sup>) maximum, with a distance between expansion joints not exceeding 8 lineal meters (314.96")
- The particularities of each installation should be taken into account.

Novojunta® 1 PVC

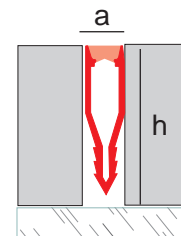

Profile height (h)	Visible width (a)	Horizontal movement	Packaging	Color	REFERENCE
25 mm (0.98")	8 mm (0.31")	1,4 mm (+0.7/-0.7) 0.055" (+0.027/-0.027)	50 u.	White	NJ1PV25BL
				Grey	NJ1PV25GR
				Beige	NJ1PV25BE
				Brown	NJ1PV25MA
				Black	NJ1PV25NE
				Mocha	NJ1PV25MO
30 mm (1.18")	8 mm (0.31")	1,4 mm (+0.7/-0.7) 0.055" (+0.027/-0.027)	50 u.	White	NJ1PV30BL
				Grey	NJ1PV30GR
				Beige	NJ1PV30BE
				Brown	NJ1PV30MA
				Black	NJ1PV30NE
				Transparent	NJ1PV30TR
				Mocha	NJ1PV30MO
35 mm (1.38")	8 mm (0.31")	1,4 mm (+0.7/-0.7) 0.055" (+0.027/-0.027)	50 u.	Grey	NJ1PV35GR
				Beige	NJ1PV35BE
				Brown	NJ1PV35MA
				Black	NJ1PV35NE
40 mm (1.57")	8 mm (0.31")	1,4 mm (+0.7/-0.7) 0.055" (+0.027/-0.027)	25 u.	White	NJ1PV40BL
				Grey	NJ1PV40GR
				Beige	NJ1PV40BE
				Brown	NJ1PV40MA
50 mm (1.97")	8 mm (0.31")	1,4 mm (+0.7/-0.7) 0.055" (+0.027/-0.027)	25 u.	Black	NJ1PV40NE
				White	NJ1PV50BL
				Grey	NJ1PV50GR
				Beige	NJ1PV50BE
				Brown	NJ1PV50MA
				Black	NJ1PV50NE
Transparent	NJ1PV50TR				



# NOVOJUNTA® 2 PVC

- Movement joint made of co-extruded PVC. Consists of one rigid PVC part that efficiently protects the flooring edges, and another flexible PVC part that enables surface tensions to be absorbed.
- It consists of two natural aluminium profiles and a central body of EPDM micro-cellular rubber, with an excellent capacity for absorbing the contractions and expansions of the flooring.
- Suitable to support all kind of traffic.
- Available in up to 6 colours: white, grey, beige, brown, black and moka.
- Profiles delivered in standard lengths of 2.5 m (98.4").
- Available up to 15 mm (0.95") height



Novojunta® 2 PVC

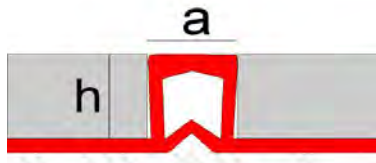

## GENERAL RECOMMENDATIONS FOR INSTALLATION

- For outdoor floorings, it is recommended closing regular areas up to 16 m<sup>2</sup> (172.22 ft<sup>2</sup>) maximum, with a distance between expansion joints not exceeding 2.5-5 lineal meters (98.42 - 196.85")
- For indoor floorings, with lower thermal change, it is recommended closing regular areas up to 40 m<sup>2</sup> (430.56 ft<sup>2</sup>) maximum, with a distance between expansion joints not exceeding 8 lineal meters (314.96")
- The particularities of each installation should be taken into account.

Profile height (h)	Visible width (a)	Horizontal movement	Packaging	Color	REFERENCE
6 mm (0.23")	8 mm (0.31")	1,4 mm (+0.7/-0.7) 0.055" (+0.027/-0.027)	50 u.	Brown	NJ2PV06MA
8 mm (0.31")	8 mm (0.31")	1,4 mm (+0.7/-0.7) 0.055" (+0.027/-0.027)	50 u.	Grey	NJ2PV08GR
				Beige	NJ2PV08BE
				Brown	NJ2PV08MA
				Black	NJ2PV08NE
10 mm (0.39")	8 mm (0.31")	1,4 mm (+0.7/-0.7) 0.055" (+0.027/-0.027)	50 u.	White	NJ2PV10BL
				Grey	NJ2PV10GR25
				Beige	NJ2PV10BE
				Brown	NJ2PV10MA
				Black	NJ2PV10NE
				Moka	NJ2PV10MO
12.5 mm (0.49")	8 mm (0.31")	1,4 mm (+0.7/-0.7) 0.055" (+0.027/-0.027)	25 u.	White	NJ2PV12BL
				Grey	NJ2PV12GR
				Beige	NJ2PV12BE
				Brown	NJ2PV12MA
				Black	NJ2PV12NE
				Moka	NJ2PV12MO
15 mm (0.59")	8 mm (0.31")	1,4 mm (+0.7/-0.7) 0.055" (+0.027/-0.027)	25 u.	Grey	NJ2PV15GR
				Brown	NJ2PV15MA
				Black	NJ2PV15NE

# NOVOJUNTA® 3 PVC



- Movement joint made of co-extruded PVC. Consists of one rigid PVC part that efficiently protects the flooring edges, and another flexible PVC part that enables surface tensions to be absorbed.
- It consists of two natural aluminium profiles and a central body of EPDM micro-cellular rubber, with an excellent capacity for absorbing the contractions and expansions of the flooring.
- Suitable to support all kind of traffic.
- Available in 5 colours: white, grey, beige, brown and black.
- Profiles delivered in standard lengths of 2.5 m (98.4").
- Available up to 15 mm (0.59") height



Novojunta® 3 PVC

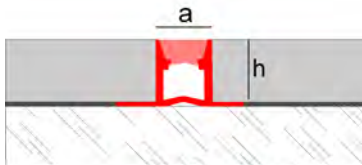

## GENERAL RECOMMENDATIONS FOR INSTALLATION

- For outdoor floorings, it is recommended closing regular areas up to 16 m<sup>2</sup> (172.22 ft<sup>2</sup>) maximum, with a distance between expansion joints not exceeding 2.5-5 lineal meters (98.42 - 196.85")
- For indoor floorings, with lower thermal change, it is recommended closing regular areas up to 40 m<sup>2</sup> (430.56 ft<sup>2</sup>) maximum, with a distance between expansion joints not exceeding 8 lineal meters (314.96")
- The particularities of each installation should be taken into account.

Profile height (h)	Visible width (a)	Horizontal movement	Packaging	Color	REFERENCE
6 mm (0.23")	8 mm (0.31")	1,4 mm (+0.7/-0.7) 0.055" (+0.027/-0.027)	50 u.	White	NJ3PV06BL
				Grey	NJ3PV06GR
				Beige	NJ3PV06BE
				Brown	NJ3PV06MA
				Black	NJ3PV06NE
8 mm (0.31")	8 mm (0.31")	1,4 mm (+0.7/-0.7) 0.055" (+0.027/-0.027)	50 u.	White	NJ3PV08BL
				Grey	NJ3PV08GR
				Beige	NJ3PV08BE
				Brown	NJ3PV08MA
				Black	NJ3PV08NE
10 mm (0.39")	8 mm (0.31")	1,4 mm (+0.7/-0.7) 0.055" (+0.027/-0.027)	50 u.	White	NJ3PV10BL
				Grey	NJ3PV10GR
				Beige	NJ3PV10BE
				Brown	NJ3PV10MA
				Black	NJ3PV10NE
12.5 mm (0.49")	8 mm (0.31")	1,4 mm (+0.7/-0.7) 0.055" (+0.027/-0.027)	50 u.	Transparent	NJ3PV10TR
				White	NJ3PV12BL
				Grey	NJ3PV12GR
				Beige	NJ3PV12BE
				Brown	NJ3PV12MA
15 mm (0.59")	8 mm (0.31")	1,4 mm (+0.7/-0.7) 0.055" (+0.027/-0.027)	50 u.	Black	NJ3PV12NE
				Transparent	NJ3PV12TR
				Grey	NJ3PV15GR
				Beige	NJ3PV15BE
				Black	NJ3PV15NE
				Transparent	NJ3PV15TR



# NOVOJUNTA® MAXI

- Profile for expansion joints made of our exclusive material Maxi, with vegetable fibers and a central flexible body made of EPDM. Decorates and absorbs the movements of expansion and contractions in floorings, thereby preventing from cracks and damage.
- The different combinations of colors of Novojunta® Maxi, fit with the latest trends and make it suitable to be installed in any environment.
- It is suitable for supporting all load types.
- Available in 5 colours: white, grey, beige, brown and black.
- Profiles supplied in standard lengths of 2.5 m (98.4").



Novojunta® Maxi

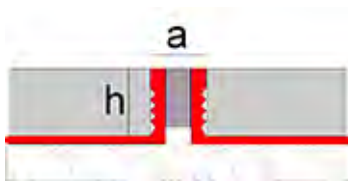

## GENERAL RECOMMENDATIONS FOR INSTALLATION

- For outdoor floorings, it is recommended closing regular areas up to 16 m<sup>2</sup> (172.22 ft<sup>2</sup>) maximum, with a distance between expansion joints not exceeding 2.5-5 lineal meters (98.42 - 196.85")
- For indoor floorings, with lower thermal change, it is recommended closing regular areas up to 40 m<sup>2</sup> (430.56 ft<sup>2</sup>) maximum, with a distance between expansion joints not exceeding 8 lineal meters (314.96")
- The particularities of each installation should be taken into account.

Profile height (h)	Visible width (a)	Horizontal movement	Packaging	Color	REFERENCE
10 mm (0.39")	9.2 mm (0.36")	1.4 mm (+0.7/-0.7) 0.055" (+0.027/-0.027)	30 u.	Maxiarena	NJUMX10MAR
				Maxigrafito	NJUMX10MGF
				Maxinegro	NJUMX10MNE
12 mm (0.47")	9.2 mm (0.36")	1.4 mm (+0.7/-0.7) 0.055" (+0.027/-0.027)	30 u.	Maxiarena	NJUMX12MAR
				Maxigrafito	NJUMX12MGF
				Maxinegro	NJUMX12MNE



# 12. PROFILES AND ACCESSORIES



Our Technical Department (tecnico@emac.es) may assist you choosing the most appropriate profile ensuring the correct application fulfilling the CTE (Spanish Technical Building Code) and the recommendations included in the Norm UNE 138002:2017 (General Regulations for the execution of wall and floor tiles by adhesion).

# NOVOPARED-SUELO ASTRA® KOMBU

EXCLUSIVE MATERIAL



- This is a multi-purpose profile, and can be installed as a finish to protect and decorate the borders of ceramic cladding, as a paving separator, or as a counter top finish.
- ASTRA® Kombu is a profile suitable for all kind of environments, both indoors / outdoors and in humid or submerged environments.
- The material offers excellent resistance to impact, meaning it can reliably be used as a profile in paving and borders.
- The colors in the range are stable and durable outdoors.
- Innovative fluted finish with non-slip characteristics that improves its behavior in the outdoors environments.
- Installation profile before work, glued or screwed.
- Profiles supplied in standard lengths of 2.5 m (98.4")

h	Packaging	Profile length	Color	REFERENCE
10 mm (0.39")	80 ud.	2,5 m (98.4")	Almond	NSUASTKOM10AL25
			Cinnamon	NSUASTKOM10CA25
			Cement	NSUASTKOM10CE25
			Black	NSUASTKOM10NE25
12 mm (0.47")			Almond	NSUASTKOM12AL25
			Cinnamon	NSUASTKOM12CA25
			Cement	NSUASTKOM12CE25
			Black	NSUASTKOM12NE25

Novopared-suelo ASTRA® Nori  
Exclusive Material

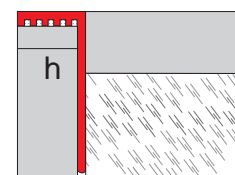
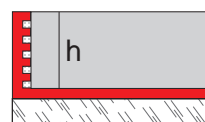



Utility model pending nº201831432

# NOVOTRI ECLIPSE® 3 USES

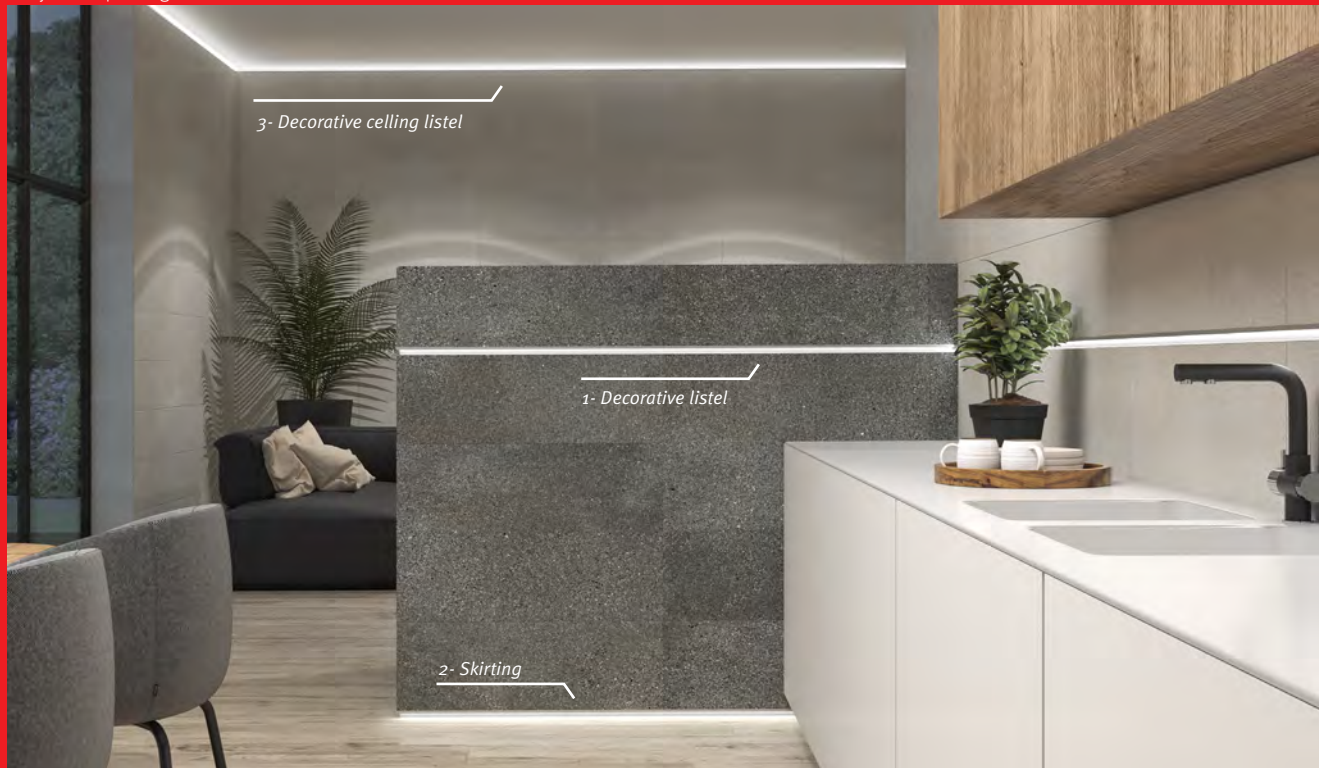

- Polyvalent profile, made of anodized aluminum, which can be placed as a decorative listel, minimalist skirting board or decorative ceiling listel in plasterboard or tiled walls.
- The front flap protects the edge of the piece that goes with and acts like a guide for its installation with materials of different thicknesses.
- Its flat base with a slight slope facilitates the cleaning and allows its installation as a skirting or top ending.
- Optionally a LED strip can be installed in the interior hollow, providing the profile with a double functionality and a high decorative value.
- Available in matt silver, off-white and matt black anod. aluminium and 70 mm (2.77").
- Profiles supplied in standard lengths of 2.5 m (98.4").

Novotri Eclipse®

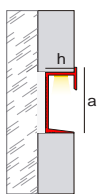

decorative listel

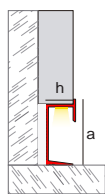

skirting

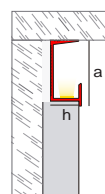

decorative ceiling listel

Height (a)	Depth (h)	Packaging	color	REFERENCE
27 mm	11 mm	30 ud.	anod. matt silver	NLECAL1125PL
			off-white	NLECAL1125BLR
			anod. matt black	NLECAL1125NM

with a plastic film\*

\*Promotional atmosphere created using Novotri Eclipse® Aluminium matt silver, showing a suggestion for one possible use of this product. EMAC® does not manufacture, sell or supply any LED strip whatsoever with the Novotri Eclipse® product. The choice of LED strip should be undertaken by the installer, taking into account the circumstances of the installation site.



EMAC COMPLEMENTOS, S.L. • Avda. Madrid 6 • 46930 Quart de Poblet, Valencia, Spain • Tel.: (+34) 961 532 200 - Fax: (+34) 961 532 261 • info@emac.es  
EMAC ITALIA S.R.L. • Via Emilia-Romagna 104 • 41049 Sassuolo (Mo), Italia • Tel.: (+39) 0536994854 - Fax: (+39) 0536889025 • info@emac-italia.it  
EMAC AMERICA, L.L.C. • 1970 NW 129 Avenue, Unit # 103 • Miami, FL 33182 • Phone: # (305) 406 1593 - Fax: (305) 406 1793 • info@emac-america.com

en.emac.es

# NOVOPILASTRA®



Reg. 504253-1

- Profile made of anodized aluminium intended to be installed as an edge protector. Its main function is to protect and decorate the edges of tiled walls, avoiding possible miter cuts.
- It is perfect to finish and protect wall corners and work surfaces and to beautify wall tiles in an industrial style environment. Currently, it is one of the most important decorative trends.
- Available in two different sizes: 8/10 mm (0.31/0.39") and 12/15 mm (0.47/0.56").
- Profiles supplied in standard lengths of 2.5 m (98.4")



Novopilastra®

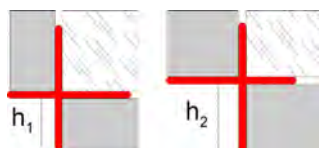

*Profile height (h <sub>1</sub> , h <sub>2</sub> )	Packaging	Color	REFERENCE
8/10 mm (0.31/0.39")	30 u.	white	NPIAL0810BL
		natural	NPIAL0810NA
		anod. bright silver	NPIAL0810PB
		anod. matt silver	NPIAL0810PL
		anod. matt black	NPIAL0810NEM
		anod. bright black	NPIAL0810NEB
12/15 mm (0.47/0.56")	30 u.	white	NPIAL1215BL
		natural	NPIAL1215NA
		anod. bright silver	NPIAL1215PB
		anod. matt silver	NPIAL1215PL
		anod. matt black	NPIAL1215NEM
		anod. bright black	NPIAL1215NEB

# NOVOBISEL®

- Profile made of aluminum to be installed as a corner protector to protect and decorate the edges of ceramic walls. Also useful to top off skirting boards or medium height tiled walls.
- The bevel visible side integrates with the tiling providing it with a fine and elegant finish. Available in four different trendy finishes.
- It has a complementary piece made of Zamak to allow the installation of profiles at right angles obtaining a great finish.
- Available in heights of 10 and 12 mm (0.39" and 0.47")
- Profiles supplied in standard lengths of 2.5 m (98.4")



Novobisel® aluminium



Angle pieces

Profile height (h)	Packaging	Color	REFERENCE
10 mm (3/8")	30 u.	anod. matt silver	NBISAL10PL
		anod. mirror bright protected	NBISAL10PB
		anod. brushed mirror-bright	NBISAL10CESP
		white	NBISAL10BL
12 mm (0.47")	30 u.	anod. matt silver	NBISAL12PL
		anod. mirror bright protected	NBISAL12PB
		anod. brushed mirror-bright	NBISAL12CESP
		white	NBISAL12BL

# NOVOLISTEL® XS

- Decorative profile of high brightness stainless steel AISI-304, of a square cross-section.
- It has multiple uses. It can be used as decorative trim, a dividing joint, a transition profile between different pavings, a corner piece, a step edge, handrail finishing, etc.
- Available in heights of 10 and 12 mm (0.39" and 0.47").
- Profiles supplied in standard lengths of 2.5 m (98.4").

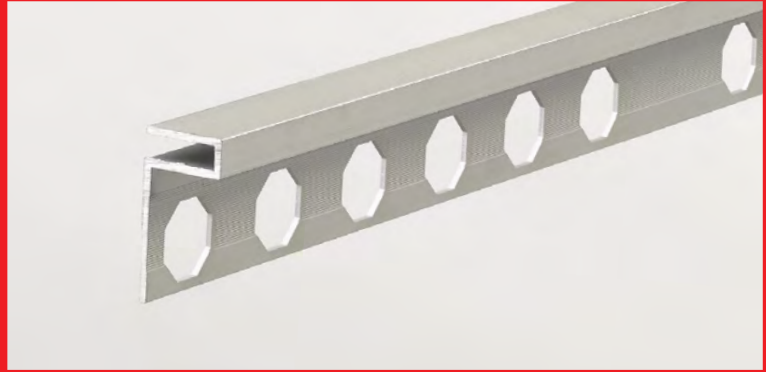

Novolistel® XS stainless steel

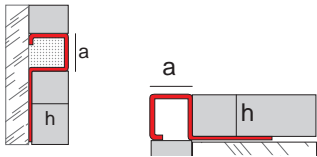

Height profile (h)	Visible width (a)	Packaging	Finish	REFERENCE
10 mm (0.39")	8 mm (0.31")	25 u.	High brightness	NLBAI10NA25
12 mm (0.47")	8 mm (0.31")			NLBAI12NA25

Novolistel® XS aluminium

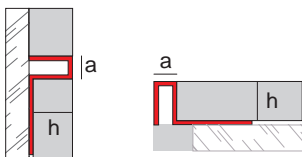

Height profile (h)	Visible width (a)	Packaging	Finish	REFERENCE
10 mm (0.39")	6,4 mm (2.52")	30 u.	matt silver	NL3XSAL10PL
10 mm (0.39")			anod. mirror bright	NL3XSAL10PB
10 mm (0.39")	6,4 mm (2.52")	30 u.	Matt silver	NL3XSAL12PL
10 mm (0.39")			anod. mirror bright	NL3XSAL12PB



Reg. 504253-6

# NOVOLISTEL® 3 ALUMINIUM

- Decorative aluminium profile, square cross-section.
- It has multiple uses. It can be used as decorative trim, a dividing joint, a transition profile between different pavings, a corner piece, a step edge, handrail finishing, etc.
- Available in natural finish, matt silver anodised and mirror bright anodised.
- Available in heights of 10 and 12 mm (0.39" and 0.47"). For other heights, ask us.
- Profiles supplied in standard lengths of 2.5 m (98.4").



Novolistel® 3 aluminium

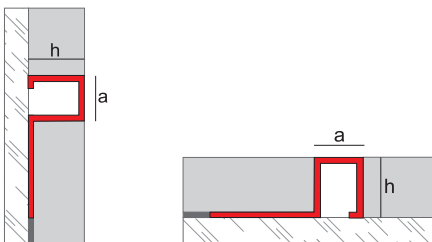

Height profile (h)	Visible width (a)	Packaging	Finish	REFERENCE
10 mm (0.39")	10 mm (0.39")	30 u.	white	NL3AL10BL
			anod. matt silver	NL3AL10PL
			anod. mirror bright	NL3AL10PB*
12 mm (0.47")	12 mm (0.47")	30 u.	white	NL3AL12BL
			anod. matt silver	NL3AL12PL
			anod. mirror bright	NL3AL12PB*

\* This model is supplied with protective film on the visible face.

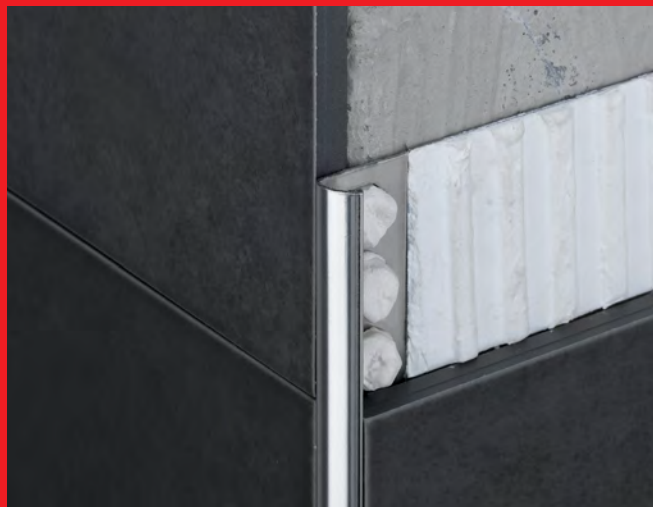

## Novocanto® Stainless steel

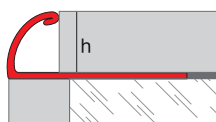

Height profile (h)	Packaging	Finish	REFERENCE
10 mm (0.39")	30 u.	High brightness	NCAA110NA
12 mm (0.47")			NCAA112NA25

- A rounded, high brightness profile of stainless steel AISI-304, employed as a corner piece to protect and decorate the corners of walls clad in ceramic tiles.
- It is installed easily in the angle formed by the cladding.
- Available in heights of 10 and 12 mm (0.39" and 0.47"). For other heights and finishes, ask us.
- Profiles supplied in standard lengths of 2.5 m (98.4").
- Supplied with protective film on the visible face.

## Novocanto® aluminium

### Angle piece

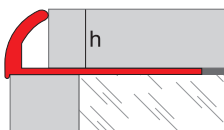

Height profile (h)	Packaging	Finish	REFERENCE
10 mm (0.39")	50 u.	Anod. matt silver	NCAAL09PL25
		Anodised mirror bright	NCAAL09PB25
		White lacquer	NCAAL10BL25
12 mm (0.47")		Anod. matt silver	NCAAL12PL25
		Anodised mirror bright	NCAAL12PB25
		White lacquer	NCAAL12BL25

- Rounded aluminium profile, which is employed as a corner piece to protect and decorate wall corners clad with ceramic tiles, providing the resistance and lightness of aluminium.
- It is installed easily in the angle formed by the cladding.
- It can further be employed as a finish on skirting boards for other types of cladding such as parquet, carpet, natural stone, etc.
- Available in a natural finish, matt silver anodised, mirror bright anodised and white lacquer.
- Available in heights of 10 and 12 mm (0.39" and 0.47"). For other heights and finishes, ask us.
- Profiles supplied in standard lengths of 2.5 m (98.4").

## Novocanto® PVC



Reg. 155585-J

### Angle piece

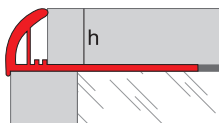

*Height profile (h)	Packaging	Color	REFERENCE
10 mm (0.39")	100 u.	White	NCAPV10BL25
		Grey	NCAPV10GR25
		Beige	NCAPV10BE25
12 mm (0.47")	100 u.	Blanco	NCAPV12BL25
		Gris	NCAPV12GR25
		Beige	NCAPV12BE25

- A rounded PVC profile, employed as a corner piece to protect and decorate the corners of walls clad in ceramic tiles.
- It is installed easily in the angle formed by the cladding.
- It can further be employed as a finish on skirting boards for other types of cladding such as parquet, carpet, natural stone, etc.
- Available in white and grey and in heights of 10 and 12 mm (0.39" and 0.47"). For other colours and heights, ask us.

\* For other measures, ask us.

# NOVOPARED-NOVOSUELO



Height profile (h)	Packaging	Finish	REFERENCE
4,5 mm (0.18")	50 u.	Natural	NSUAL04NA25
		Matt silver	NSUAL04PL25
6 mm (0.23")	50 u.	Natural	NSUAL06NA25
		Matt silver	NSUAL06PL25
8 mm (0.31")	50 u.	Natural	NSUAL08NA25
		Matt silver	NSUAL08PL25
10 mm (0.39")	50 u.	Natural	NSUAL10NA25
		Matt silver	NSUAL10PL25
12.5 mm (0.49")	50 u.	Natural	NSUAL12NA25
		Matt silver	NSUAL12PL25
15 mm (0.59")	50 u.	Natural	NSUAL15NA25
		Matt silver	NSUAL15PL25
17,5 mm (0.69")	50 u.	Natural	NSUAL17NA25
20 mm (0.79")	50 u.	Natural	NSUAL20NA25
		Matt silver	NSUAL20PL25
22.5 mm (0.88")	50 u.	Natural	NSUAL22NA25
25 mm (0.98")	50 u.	Natural	NSUAL25NA25
27,5 mm (1.08")	50 u.	Natural	NSUAL27NA*
30 mm (1.18")	50 u.	Natural	NSUAL30NA25

\* This model is supplied in lengths of 3 m (118").

Height profile (h)	Packaging	Finish	REFERENCE
8 mm (0.31")	30 u.	Natural	NSULT08NA25
10 mm (0.39")			NSULT10NA25
12.5 mm (0.47")			NSULT12NA25

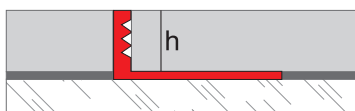

- Right-angle profile in natural aluminium, with multiple uses.
- It can be used as a beautifier of joints between different materials, to separate paving, or as a corner protector.
- It can be installed with claddings of between 4 and 30 mm thickness, in a wide range of measurements.
- In natural aluminum finish and matt silver anodized can be ordered curved. (check conditions)
- For other heights and finishes, ask us.
- Profiles supplied in standard lengths of 2.5 m (98.4").

Novopared-Novosuelo Aluminum

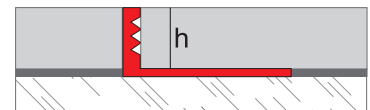

Novopared-Novosuelo Brass

- Profile with simple lines made of brass, intended to be installed as an edge protector, flooring separator, countertop finish...
- It can be installed with floor or wall tiles between 3 and 30 mm width.
- Available in natural finish

# NOVOESCUADRA ALUMINIUM



- Profile designed to protect or decorate the corners of any type of cladding.
- It is perfect for rehabilitation or reform works because it does not require alterations to be installed. It is also ideal for the protection of deteriorated or poorly finished edges on old installations.
- Available in anodized matt silver finish and white lacquer.
- Profiles supplied in standard lengths of 2.5 m (98.4").

Arm dimension (a)	Packaging	Finish	REFERENCE
20 mm (0.79")	50 u.	anod. matt silver	NECAL20PL25
		white lacquer	NECAL20BL25

Novoesquadra Aluminium

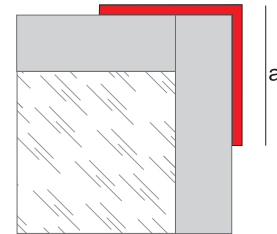

# NOVOESCUADRA PVC XL



- Novoesquadra XL is a made of PVC solution designed to protect the edges of ceramic installations or plaster walls.
- The wide visible side of this profile makes it the perfect solution to protect effectively the edges of the installations in high traffic environments such as hospitals, schools, universities, ecc.
- It is a very easy to install, aplying adhesives. The installation is after work.
- Profiles supplied in standard lengths of 2.5 m (98.4").

Arm dimension (a)	Packaging	Finish	REFERENCE
50 mm (1.97")	30 u.	White	NEXLPV50BL

Novoesquadra PVC XL





# NOVOESCUADRA PLUS

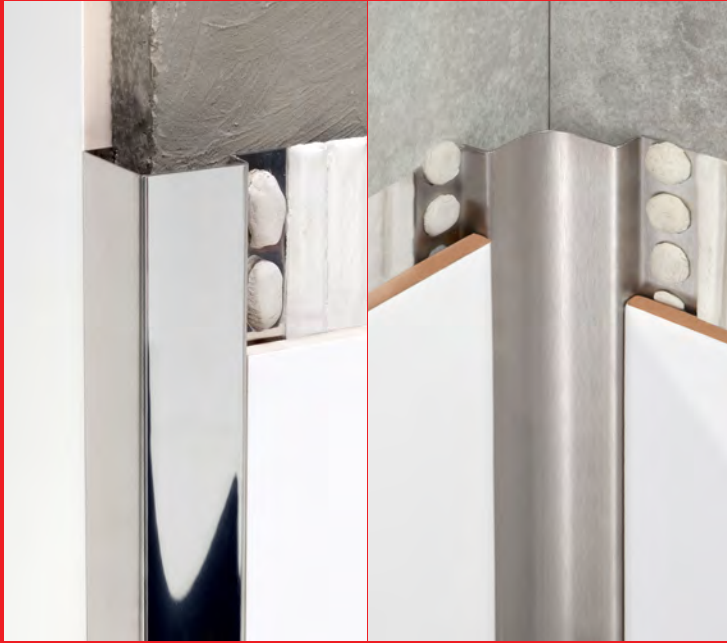

- Square angle profile with a wide visible face manufactured in stainless steel AISI-304, designed to protect external and internal angles (corners).
- Especially recommended for the food industry.
- Due to its design, it provides a finish of great beauty and resistance, both interior and exterior.
- It has two attachment arms that ensure a perfect grip.
- Available in high-bright and brushed stainless steel.
- Profiles supplied in standard lengths of 2.5 m (98.4").
- Supplied with protective film on the visible face.

Novoescuadra Plus

External angle

Internal angle

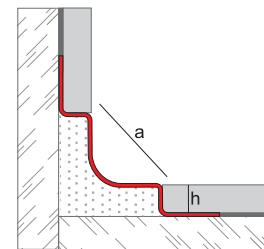
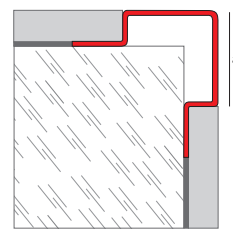

Model	Height profile (h)	Width (a)	Packaging	Finish	REFERENCE
External angle (corner)	12 mm (0.47")	37 mm (1.47")	10 u.	High brightness	NECPAI37NA25
				Brushed	NECPAI37CE25
Internal angle (corner)	10 mm (0.39")	37 mm (1.47")	10 u.	Brushed	NECPAI25IC25

# NOVOYESO

- PVC profile for plastered walls.
- Installing before plastering it helps to achieve perfectly aligned corners, providing greater resistance to knocks and scrapes.
- Profiles supplied in standard lengths of 2.5 m (98.4").



Novoyeso

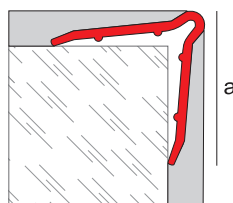

Arm dimension (a)	Packaging	Color	REFERENCE
28 mm (0.39")	100 u.	White	NYEPV25BL

# NOVOSEPARA 5

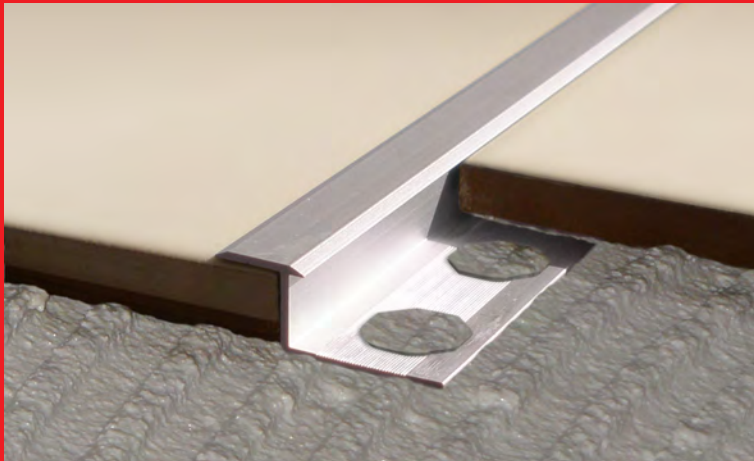

- Novosepara 5 is a profile made of aluminum, intended to be placed as a trim in joints between floors.
- Due to its geometry, the face side is overlapped in the floor.
- This profile is available in natural and matt silver finish.
- Profiles supplied in standard lengths of 2.5 m (98.4").

Height profile (h)	Visible width (a)	Packaging	Finish	REFERENCE
23 mm (0.91")	12.5 mm (4.92")	50 u.	Natural	NJDFAL30TA
			Anod. matt silver	NJDFAL30TAPL

Novosepara 5 Aluminium

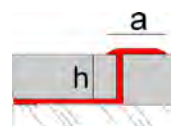

# NOVOSEPARA 10

- Profile made of matt silver anodized aluminium, designed as a decorative separator between floorings.
- Easy to install, it is installed once the flooring has been laid. The upper section covers the joint created by the tiles and its visible side embellishes the installation.
- This is a perfect profile to install on vinyl floorings, for example in fitness centers.
- It is also ideal to cover expansion joints deteriorated.
- Available in 2 lengths: 1 m and 2.5 m (39.4" and 98.4").



Novosepara 10 Aluminium

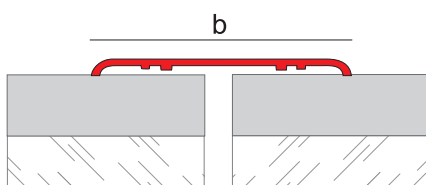

Width (b)	Packaging	Length	REFERENCE
40 mm (1.57")	50 u.	100 cm (39.4")	NS10AL40PL1
		250 cm (98.4")	NS10AL40PL25

# NOVOESCOCIA® S ANTIBACTERIAL

- Mini antibacterial scotia with reduced face side, which is attached to already installed tiling.
- The technology applied on its surface protects against harmful organisms such as molds, fungi and bacteria.
- It's ideal both installations with high levels of hygiene and cleaning and houses. Available in a range of colours with properties of microbial control.
- It is installed easily to facilitate cleaning of the skirting boards and tiled angles.
- Profiles supplied in standard lengths of 2.5 m (98.4").



Novoescocia® S

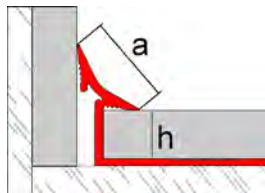

Height profile (h)	Visible width (a)	Packaging	Finish	REFERENCE
10 mm (0.39")	15.3 mm (0.60")	40 u.	antibact bright white	NEMMAL10BL25
12 mm (0.47")				NEMMAL12BL25



Angle pieces

# NOVOESCOCIA® 4 PVC

- Half-tube PVC profile, which is attached to already installed tiling to facilitate cleaning of the skirting boards and tiled angles.
- It is attached easily using a silicone-type adhesive which is also waterproof.
- Helps to comply with standard CTE-DB-HS Salubridad (Public Health), which demands in Point 2.1.3, in reference to the design of the room reserved as a container warehouse in buildings and reserve space, that "the meeting zone between walls and the floor must be rounded". Additionally, the regulation ordinances on hygiene and health care conditions indicate that the construction elements of these installations must be "easy to clean and disinfect".
- Profiles supplied in standard lengths of 2.5 m (98.4").



Novoescocia® 4 PVC

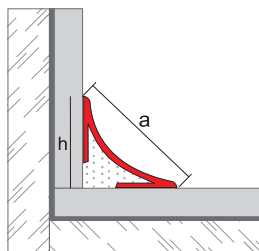

Height profile (h)	Visible width (a)	Packaging	Finish	REFERENCE
25 mm (0.98")	36.5 mm (1.44")	30 u.	White	NE4PV4OBL

# NOVOESCOCIA® 4 ALUMINIUM

- Half-tube aluminium profile, which is attached to already installed tiling to facilitate cleaning of the skirting boards and tiled angles.
- It is attached easily using a silicone-type adhesive which is also waterproof.
- Helps to comply with standard CTE-DB-HS Salubridad (Public Health), which demands in Point 2.1.3, in reference to the design of the room reserved as a container warehouse in buildings and reserve space, that "the meeting zone between walls and the floor must be rounded". Additionally, the regulation ordinances on hygiene and health care conditions indicate that the construction elements of these installations must be "easy to clean and disinfect".
- Complementary pieces are available to achieve a perfect finish: interior corner, exterior corner, interior vertical finishing covers.
- Available in natural aluminium finish and white lacquer.
- Profiles supplied in standard lengths of 2.5 m (98.4").
- Supplied with protective film on the visible face.



Novoescocia® 4 aluminium

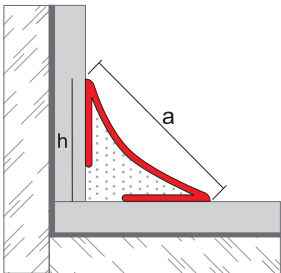

Complementary pieces:

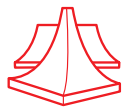

external angle

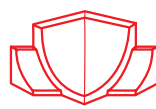

internal angle



vertical internal angle



cover

Height profile (h)	Visible width (a)	Packaging	Finish	REFERENCE
27 mm (1.06")	38 mm (1.5")	30 u.	anod. matt silver	NE4AL40PL
			white lacquer	NE4AL40BL

# MONOCAPA



- PVC profile for single-layer cladding. It leaves a perfect, permanent trace in the finishing of single-layer façades.
- It creates the effect of joints and divisions in the single layer.
- Profiles supplied in standard lengths of 2.5 m (98.4").

Height profile (h)	Width (a)	Packaging	Color	REFERENCE
6 mm (0.23")	20 mm (0.79")	100 u.	White	MONPV20GR

Monocapa

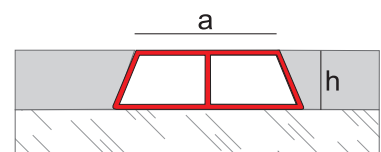

# NOVOVIERTEAGUAS GT



Reg. 201231375



Flashing board of a wide exposed face, manufactured in lacquered aluminium, ideal for finishing the border of terraces, balconies and sills. The exclusive design of its throating, grooved along its length, makes it much more effective for channelling water away from the wall, thereby stopping water from falling down the façade and causing leaks.

Novovierteaguas GT

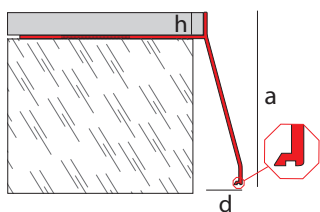

Height profile (h)	Visible width (a)	d	Packaging	Finish	REFERENCE
10 mm (0.39")	75 mm (2.95")	20 mm (0.79")	6 u.	Light grey	NVGTAL10GC
				Oxidized grey	NVGTAL10OG



Corner and joint pieces

# 13. SKIRTINGS



Our Technical Department (tecnico@emac.es) may assist you choosing the most appropriate profile ensuring the correct application fulfilling the CTE (Spanish Technical Building Code) and the recommendations included in the Norm UNE 138002:2017 (General Regulations for the execution of wall and floor tiles by adhesion).

# NOVORODAPIE ECLIPSE® SP



- Profile made of aluminum to be installed as a skirting with all types of coatings.
- Its geometry of straight lines allows to cover the perimeter joint and facilitates cleaning.
- It is a highly versatile and reversible profile. It can be placed, in addition to a skirting board, as an intermediate or upper finish on the wall in two different positions.
- Optionally a LED strip can be installed (not included) in any of the interior holes, providing the profile with a double functionality and a high decorative value and being able to choose between a more discreet or more visible lighting.
- Available in anod, matt silver in height 80 mm and with end caps available.
- Profiles supplied in standard lengths of 2.5 m (98.4").

Novorodapie Eclipse® SP

Complements (caps)

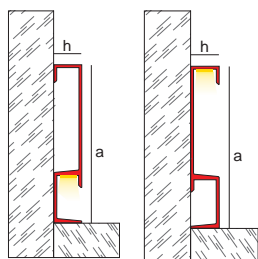

a	h	Packaging	Color	REFERENCE
80 mm	25 mm	15 ud.	Plata Mate	NRECSPAL80PL

with a plastic film\*

# NOVORODAPIE ECLIPSE®

- Profile made of aluminum to be installed as a skirting in plasterboard walls.
- Thanks to its geometry, the profile protects the bottom edge of the wall, generating an innovative hollow effect like if the wall was suspended in the air.
- Its simple lines, finished with a small curve, create a smooth surface that avoids the accumulation of dirtiness and makes easy the cleaning.
- In addition to be a skirting, this profile can also be a finish the top of the wall.
- Optionally a LED strip can be installed in the interior hollow, providing the profile with a double functionality and a high decorative value.
- Available in matt silver, off-white and matt black anod. aluminium and 70 mm (2.77")
- Profiles supplied in standard lengths of 2.5 m (98.4").



Novorodapie Eclipse®

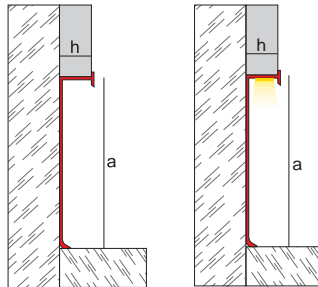

Height (a)	Depth(h)	Packaging	Color	REFERENCE
70 mm (2.77")	13 mm (0.51")	10 u.	anod. matt silver	NRECAL1370PL
			off-white	NRECAL1370BL
	anod. matt black		NRECAL1370NM*	
	anod. matt silver		NRECAL1570PL	
	off-white		NRECAL1570BL	
	anod. matt black		NRECAL1570NM*	

 with a plastic film\*

# NOVORODAPIE® SEMIFLEX

- Skirting manufactured in semi-rigid, flexible PVC.
- It adapts to the irregularities of paving. Thanks to its flexibility, it can also be installed in a curve.
- It incorporates beading scotia along its lower edge to aid cleaning, which makes it ideal for buildings with high demands in hygiene such as hospitals, schools, shopping centres, etc.
- Attachment using contact cement (follow instructions in the technical file).
- Available in white and grey.
- Profiles supplied in standard lengths of 2.5 m (98.4").



Novorodapie® Semiflex

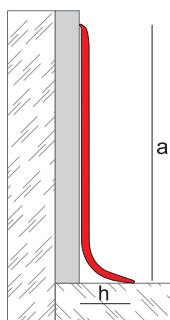

Height (a)	Depth (h)	Packaging	Color	REFERENCE
60 mm (2.36")	15 mm (0.59")	10 u.	White	NRSFPV60BL2
80 mm (3.15")			Grey	NRSFPV60GR2
			White	NRSFPV80BL2
100 mm (3.94")			Grey	NRSFPV80GR2
			White	NRSFPV100BL2
			Grey	NRSFPV100GR2



# NOVORODAPIE® REHABIT



Reg. 1685256-7



- Skirting of a modern design, manufactured in matt silver anodised aluminium, especially designed for building rehabilitation or renovation.
- It can be installed in two different ways: over pre-existing skirting board, saving time and installation costs, or onto the wall itself using the profiles for placement (2 meters length).
- Available in 2 heights: 80 and 120 mm (3.15" and 4.72").
- Profiles supplied in standard lengths of 2 m (78.7").
- Supplied with protective film on the visible face.
- For a perfect finish or installation, finishing covers for left and right and interior and exterior corners are available.

Height (a)	Depth (h)	Packaging	Finish	REFERENCE
80 mm (3.15")	12 mm (0.47")	10 u.	Anod. matt silver	NRHAL80PL
			Off-white	NRHAL80BLR
120 mm (4.72")	20 mm (0.79")		Anod. matt silver	NRHAL120PL
			Off-white	NRHAL120BLR

Complementary pieces:

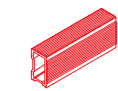

profile for placement (length 2 ml)



external angle



internal angle



cover

Novorodapie® Rehabit

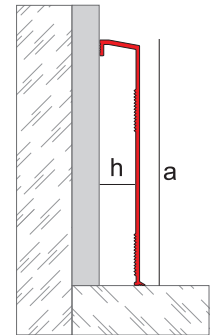

# NOVORODAPIE® L



- Skirting manufactured matt silver anodised aluminium, easily installed thanks to its auto-adhesive strips.
- Original, lasting finish.
- Its lower lip allows it to mask the perimeter joint, allowing pavement expansion.
- Available in 3 heights: 60, 80 and 100 mm (2.36", 3.15" and 3.94").
- Profiles supplied in standard lengths of 3 m (118").

Height (a)	Depth (h)	Packaging	Finish	REFERENCE
60 mm (2.36")	15 mm (0.59")	20 u.	Anod. matt silver	NRLAL60PL25
			Off-white	NRLAL60BLR25
80 mm (3.15")		10 u.	Anod. matt silver	NRLAL80PL25
			Off-white	NRLAL80BLR25
100 mm (3.94")			Anod. matt silver	NRLAL100PL25
			Off-white	NRLAL100BLR

Novorodapie® L

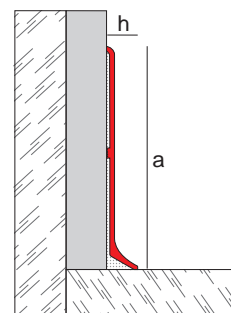

# 14. STEP FINISHES



Our Technical Department (tecnico@emac.es) may assist you choosing the most appropriate profile ensuring the correct application fulfilling the CTE (Spanish Technical Building Code) and the recommendations included in the Norm UNE 138002:2017 (General Regulations for the execution of wall and floor tiles by adhesion).

# NOVOPELDAÑO ASTRA® NORI

EXCLUSIVE MATERIAL



Watch explanatory video capturing this QR code with your Smartphone or entering our corporate channel on Youtube (<http://www.youtube.com/user/emac complementos>).



- Stair nosing profile made of the EMAC® exclusive ASTRA® material.
- ASTRA® is an extra resistant polymer specially developed to obtain the best benefits in all kind of environments. Not only indoors but also in submerged or humid environments or outdoors.
- This material has a great impact resistance, improved in the formulation with several additives and a perfect balance of mineral reinforcer.
- The colors available are stable and durable.
- This stair nosing profile is to be installed after the tiling work with adhesive or screws.
- Installation profile after adhesive or tightening work.
- Profiles supplied in standard lengths of 2.5 m.

Novopeldaño ASTRA® Nori  
Exclusive Material

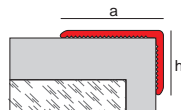

a	h	Packaging	Length profile	REFERENCE
40 mm (1.57")	25 mm (0.98")	15 ud.	2,5 m (78.7")	NPASTNOCA25
				NPASTNOCE25
				NPASTNONE25



224.I.1712.0001.ES.01  
21705376\_R-1

# NOVOPELDAÑO ECLIPSE®



\*Notice



- Stair nosing profile, made of aluminum, designed to protect and decorate tiled stairs.
- Its design, with a hidden hollow, allows the installation of any LED strip chosen by the installer without need of difusor.
- Its visible side improves the slip resistance value of the stair.
- Thanks to its geometry, the slight slope allows the evacuation of water outside, avoids the accumulation of dirt and makes easy the cleaning.
- Solution in one piece with easy and fast installation.
- Suitable for outdoor
- Special cover available.
- Product tested against impacts and loading capacity
- Profiles supplied in standard lengths of 2.5 m (39.4" or 98.4").

## Novopeldaño Eclipse®

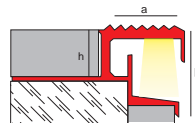
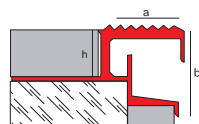

\*224.I.1712.0001.ES.01  
\*21705376\_R-1

\*Product tested against impacts and loading capacity

a	b	h	Packaging	Length profile	REFERENCE
22 mm (0.87")	22.5 mm (0.89")	10 mm (0.39")	15 u.	2.5 m (78.7")	NPECAL10PL
		12 mm (0.47")	12 u.	2.5 m (78.7")	NPECAL12PL

Complements:

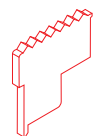

cover

\*Promotional atmosphere created using Novopeldaño Eclipse® Aluminium matt silver, showing a suggestion for one possible use of this product. EMAC® does not manufacture, sell or supply any LED strip whatsoever with the Novopeldaño Eclipse® product. The choice of LED strip should be undertaken by the installer, taking into account the circumstances of the installation site.

# NOVOPELDAÑO® 4



Reg. 504253-4



- Stair-nosing profile, made of aluminum and stainless steel, designed to protect and decorate the edge of tiled stairs.
- Its striated visible side acts as a slip-resistant element and increases the safety of stair edges.
- Its design integrates perfectly the tiles and gives the stairs an elegant touch.
- Suitable for outdoor
- Special cover available.
- Profiles supplied in standard lengths of 1 or 2 m (39.37 or 78.7")

Novopeldaño®4 Aluminium

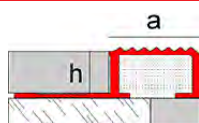

Width (a)	Height (h)	Packaging	Length profile*	REFERENCE
22 mm (0.87")	10 mm (0.39")	20 u.	1 / 2.5 m (39.37 / 78.7")	NP4AL22PL*
	12 mm (0.47")		1 / 2.5 m. (39.37 / 78.7")	NP4AL2212PL*

\*Elegir longitud entre las disponibles.

Novopeldaño® 4 Stainless steel

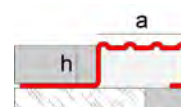

Width (a)	Height (h)	Packaging	Length profile*	REFERENCE
25 mm (0.98")	11 mm (0.43")	10 u.	1 / 2.5 m (39.37 / 78.7")	NP4AI25NA

Complements:

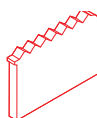

cover

Complements:

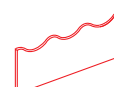

T cover



corner

# NOVOPELDAÑO® 5



Reg. 504253-5

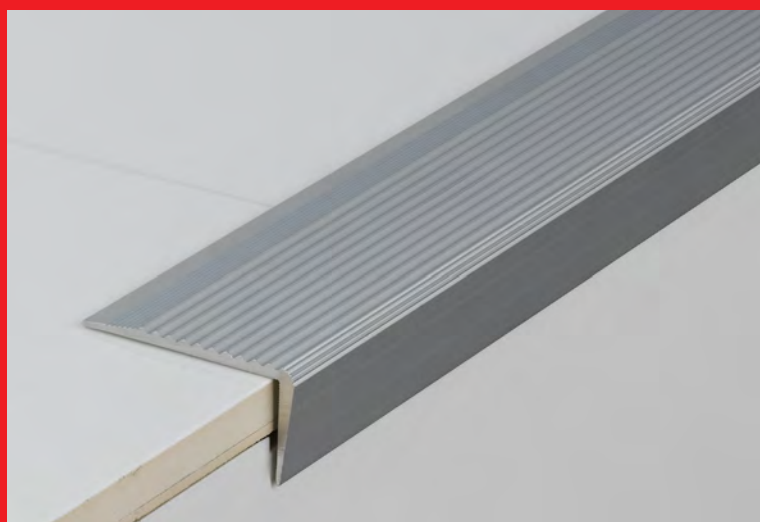

- Matt silver anodised aluminium profile, designed for the edging on steps.
- It has a grooved, anti-slip surface.
- It is attached easily to any type of paving and is ideal for the finishing of deteriorated tile steps as it covers any imperfections.
- Inalterable on the outside.
- Profiles supplied in standard lengths of 1 m or 2.5 m (39.4" or 98.4").
- When ordered, it can be supplied with adhesive or with countersunk holes for screw attachment (not included)
- Indoor and outdoor.

Novopeldaño® 5

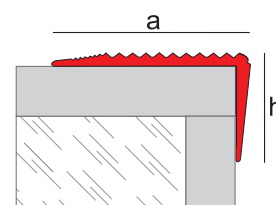

Width (a)	Height (h)	Packaging	Length profile	REFERENCE
42 mm (1.65")	22 mm (0.87")	20 u.	100 cm (39.4")	NP5AL42PL1
			250 cm (98.4")	NP5AL42PL



Reg. 1685256-2

## NOVOPELDAÑO® MAXIKENYA



Stair nosing profile made of Maxi, an EMAC® exclusive raw material which belongs to the WPC (Wood Plastic Composite) family of products. Its striated surface increases the value of slip resistance of the flooring. The range MaxiKenya is specially recommended for outdoor installations because it has an excellent weatherability and remains unalterable to sun exposure.

Novopeldaño® MaxiKenya

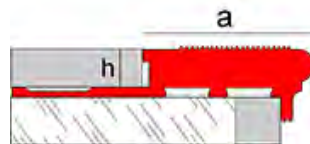

## NOVOPELDAÑO® MAXIDAKAR

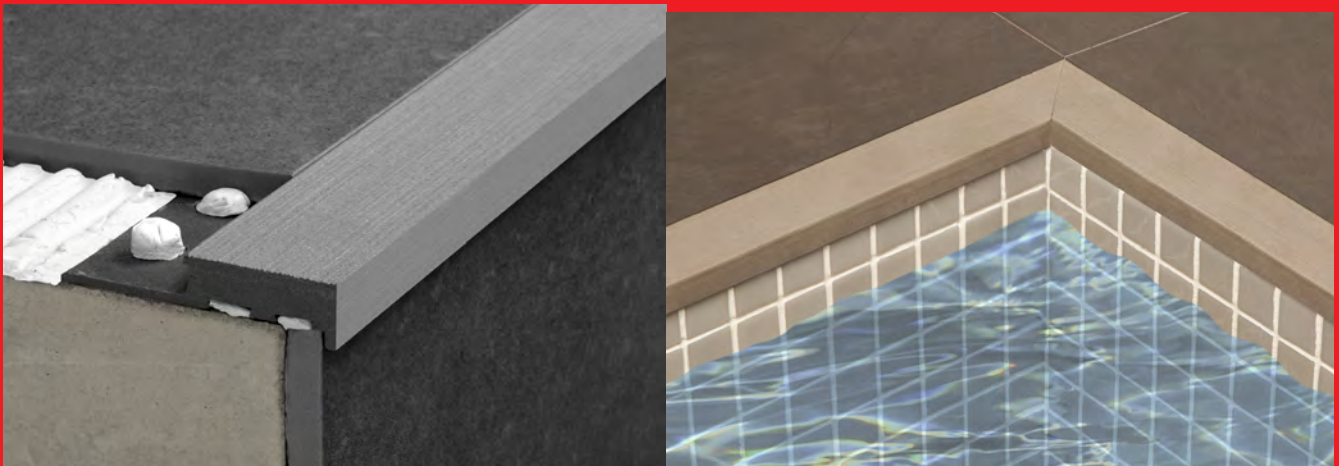

Stair nosing profile made of Maxi, an EMAC® exclusive raw material which belongs to the WPC (Wood Plastic Composite) family of products. Its striated surface increases the value of slip resistance of the flooring. The range MaxiDakar is specially recommended for outdoor installations because it has an excellent weatherability and remains unalterable to sun exposure.

Novopeldaño® MaxiDakar



# NOVOPELDAÑO® SAFETY



Reg. 1988882-C

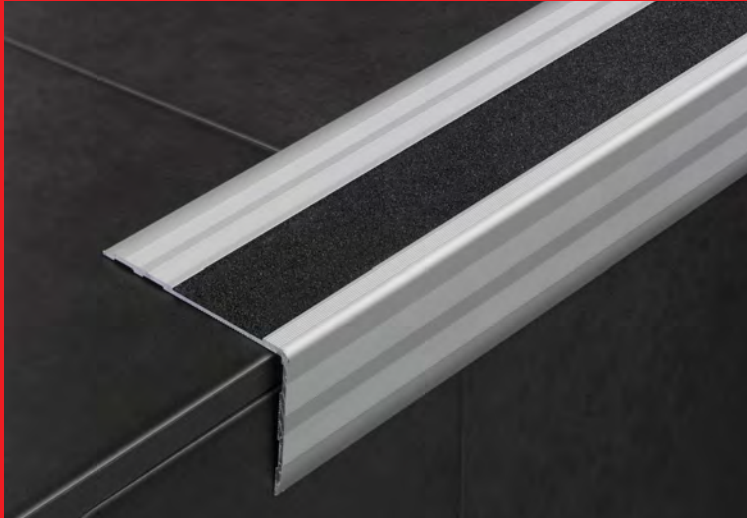

- An aluminium profile finished in matt silver that offers maximum slip resistance thanks to its ridged surface and, above all, to its non-slip, 3-cm wide band.
- It is attached easily to any type of paving and is ideal for the finishing of deteriorated tile steps as it covers any imperfections.
- This is the ideal solution on steps in public places with dense traffic, both inside and outside.
- The anti-slip strip, of aluminium oxide, has a certified anti-slip rating of R13 according to standard DIN51130.
- The contrast between the profile and the strip furthermore guarantee its suitability within the guidelines offered in accessibility guides.
- Profiles supplied in standard lengths of 1 m or 2.5 m (39.4" or 98.4").
- Supplied with protective film on the visible face.

Width (a)	Strip width(ad)	Height (h)	Packaging	Length profile*	Strip color	REFERENCE
65 mm (2.56")	30 mm (1.18")	40 mm (1.57")	10 u.	1 / 2.5 m. (39.4 / 98.4")	black	NPSFAL65PL
					grey	NPSFAL65GR
					yellow	NPSFAL65AM
					yellow/black	NPSFAL65AN

\*Mark desired length among the available ones

Novopeldaño® Safety

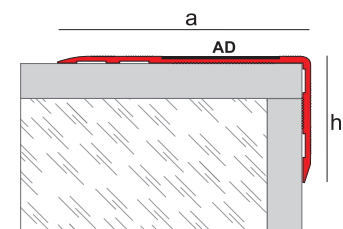

# NOVOPELDAÑO® SAFETY PLUS



- Non-slip stair nosing profile. Its wide striated surface and its non-slip strip fulfill with the most demanding safety standards, increasing the value of slip resistance of any flooring. It is installed after tiling.
- The contrast between the strip and the aluminum profile helps to make it DDA compliant.
- Ideal for public areas with heavy pedestrian (foot) traffic.
- This strip is available in contrast colors such as black, yellow/black, yellow or even grey if you want a more decorative finish.
- Profiles supplied in standard lengths of 1 m or 2.5 m (39.4" or 98.4").

Width (a)	Strip width (ad)	Height (h)	Packaging	Length profile*	Strip color	REFERENCIE
44 mm (1.73")	30 mm (1.81")	10 mm (0.39")	10 u.	1 / 2.5 m. (39.4 / 98.4")	black	NPSFPAL10NE
					grey	NPSFPAL10GR
					yellow	NPSFPAL10AM
					yellow/black	NPSFPAL10AN
		12.5 mm (4.92")	10 u.		black	NPSFPAL12NE
					grey	NPSFPAL12GR
					yellow	NPSFPAL12AM
					yellow/black	NPSFPAL12AN

\*Mark desired length among the available ones

Novopeldaño® Safety Plus

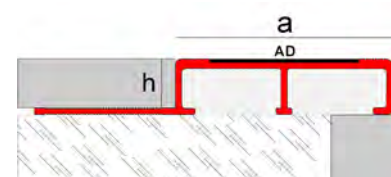



Reg. 1988882-2

# NOVOPELDAÑO LUMINA®

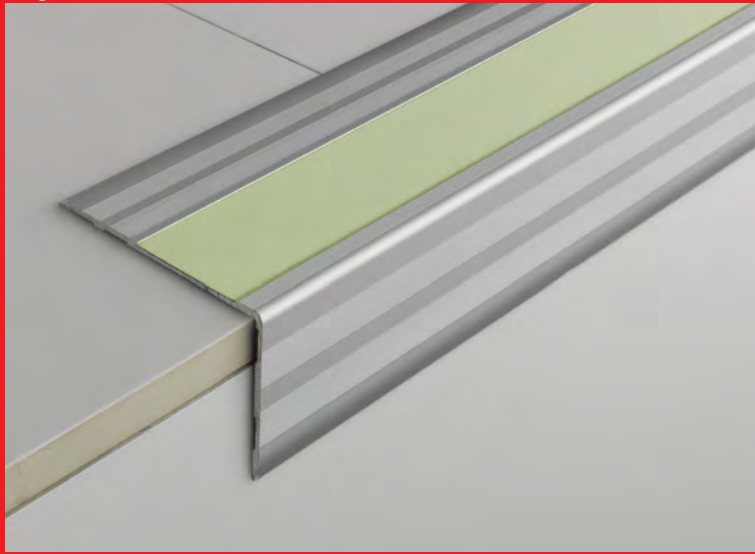

- Aluminium profiles with a ridged, non-slip surface plus a high-quality photoluminescent band which glows in the dark.
- They with the strictest standards in the area of emergency signalling. In fact, the photoluminescent strip (Class B) amply surpasses the demands in terms of luminescence set by standard UNE 23035-4.
- It is attached easily to any type of paving and is ideal for the finishing of deteriorated tile steps as it covers any imperfections.
- This is the ideal solution on steps in public places with dense traffic, both inside and outside. It has high resistance to wear.
- Available in 2 sizes of profile and photoluminescent band.
- The large model, with a photoluminescent strip 3 cm (1.18") wide, can be attached to indicate the tread or riser depending on whether the evacuation direction is up or down.
- Profiles supplied in standard lengths of 1 m or 2.5 m (39.4" or 98.4").
- Supplied with protective film on the visible face.

## Novopeldaño® Lúmina

Width (a)	Strip width (f)	Height (h)	Packaging	Length profile	REFERENCE
48 mm (1.89")	5 mm (0.2")	25 mm (0.98")	15 u.	100 cm	NPLUAL48PL1
				250 cm	NPLUAL48PL25
65 mm (2.56")	30 mm (1.18")	40 mm (1.57")	10 u.	100 cm	NPLUAL65PL1
				250 cm	NPLUAL65PL25

## Novopeldaño® Lúmina 65 mm

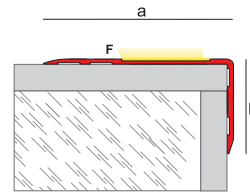

## Novopeldaño® Lúmina 48 mm

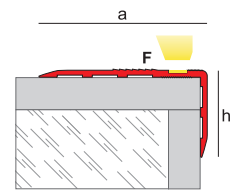

# NOVOPELDAÑO LUMINA® PLUS



- Aluminium profiles with a ridged, non-slip surface plus a high-quality photoluminescent band which glows in the dark.
- They with the strictest standards in the area of emergency signalling. In fact, the photoluminescent strip (Class B) amply surpasses the demands in terms of luminescence set by standard UNE 23035-4.
- It is attached easily to any type of paving and is ideal for the finishing of deteriorated tile steps as it covers any imperfections.
- This is the ideal solution on steps in public places with dense traffic, both inside and outside. It has high resistance to wear.
- Available in 2 sizes of profile and photoluminescent band.
- The large model, with a photoluminescent strip 3 cm (1.18") wide, can be attached to indicate the tread or riser depending on whether the evacuation direction is up or down.
- Profiles supplied in standard lengths of 1 m or 2.5 m (39.4" or 98.4").
- Supplied with protective film on the visible face.

## Novopeldaño® Lúmina Plus

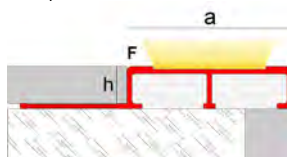

Width (a)	Strip width (f)	Height (h)	Packaging	Length profile	REFERENCE
44 mm (1.73")	30 mm (1.81")	10 mm (0.39")	20 u.	100 cm (39.37")	NPLUPAL10PL1
				250 cm (98.42")	NPLUPAL10PL
		12 mm (0.47")	20 u.	100 cm (39.37")	NPLUPAL12PL1
				250 cm (98.42")	NPLUPAL12PL



# 15. UNIVERSAL ACCESSIBILITY & SAFETY



Our Technical Department (tecnico@emac.es) may assist you choosing the most appropriate profile ensuring the correct application fulfilling the CTE (Spanish Technical Building Code) and the recommendations included in the Norm UNE 138002:2017 (General Regulations for the execution of wall and floor tiles by adhesion).

# PODOTACTILE SYSTEM

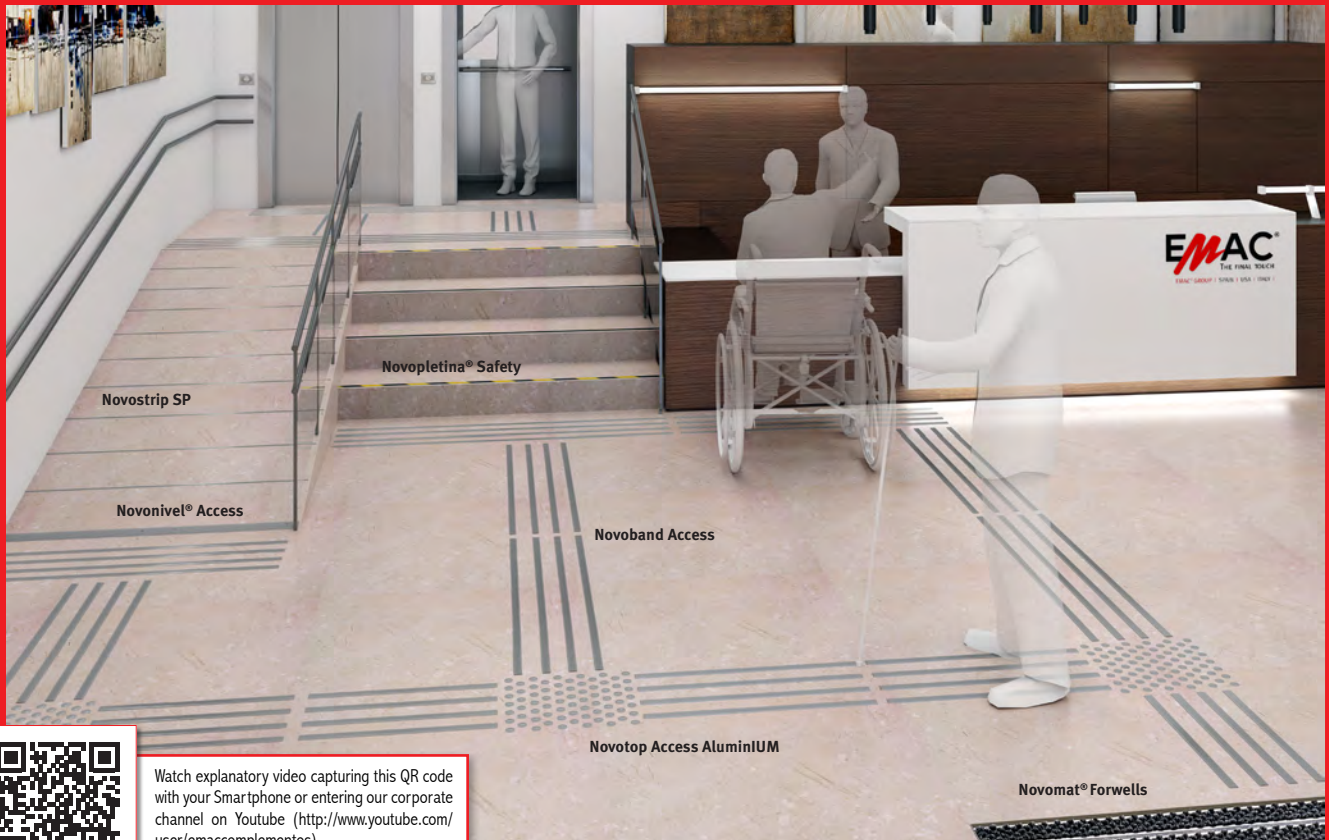

Watch explanatory video capturing this QR code with your Smartphone or entering our corporate channel on Youtube (<http://www.youtube.com/user/emac complementos>).

# NOVOBAND ACCESS



- Profile made of natural aluminum designed to be installed as an element of guidance for people with visual disabilities within the Emac®'s Universal Accessibility and Safety System.
- This profile is easy to install on finished floorings.
- Available in heights 3 and 5 mm to facilitate its placement complying with the requirements of different countries for indoor and outdoor.
- Existe una plantilla de colocación disponible de forma opcional, para orientar en el posicionamiento de las bandas acorde a lo establecido en las normativas.
- Profiles supplied in standard lengths of 2 m.

Novoband Access

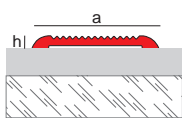

h: 3 mm

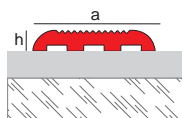

h: 5 mm

Material	h	a	Packaging	Color	REFERENCE
Aluminium	3 mm (0.12")	30 mm (1.18")	30 ud.	natural	NPLEAL3NA
	5 mm (0.20")				NPLEAL5NA
Installation template	-	295,5 x 285 mm (11.63 x 11.22")	1 ud.	-	NPLEFIJALU

# NOVOTOP ACCESS ALUMINIUM



- Tactile nails provide a warning solution to identify areas with obstacles, or areas where there is a change of level or an unprotected gap, such as staircases and open platforms.
- According to its tactile texture, and its anti-slip design, they are easily identified by users.
- With the fitting template, the nails layout is adjusted optimally for the tactile function and the installation is simplified.
- Available in natural aluminium and 3 mm (0.12") and 5 mm (0.20") of heightness.

Novotop Access Aluminium

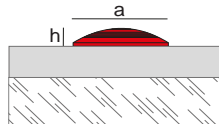

Installation template  
Novotop Access Aluminium

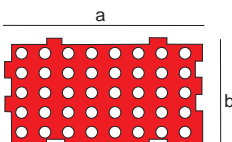

Material	h	a	Packaging	Color	REFERENCE
Aluminium	3 mm (0.12")	25 mm (1")	500 u./bag	Natural bright	NTOPAL3BRNA
			1 u.		NTOPAL3BRNA1
Aluminium	5 mm (0.20")	25 mm (1")	500 u./bag	Natural bright	NTOPAL5BRNA
			1 u.		NTOPAL5BRNA1
Installation template Novotop Access Alum.	435 x 225 mm (17.13" x 8.86")		1 u.	-	NTOPFIJALU

# NOVOTOP ACCESS ZINC PLATED



- Tactile nails provide a warning solution to identify areas with obstacles, or areas where there is a change of level or an unprotected gap, such as staircases and open platforms.
- According to its tactile texture, and its anti-slip design, they are easily identified by users.
- These nails, special for outdoor areas, have an innovative installation system that avoids using adhesives, minimizing considerably so the execution times and reducing the material costs.
- They can be installed by using the installation template (in option).

Novotop Access Zinc plated

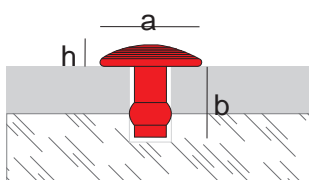

Material	h	a	b	Packaging	Color	REFERENCE
Zinc plated	5 mm (0.20")	25 mm (1")	17,5 mm	250 u./bag	zinc	NTOPACM
				1 u.		NTOPACM1
Installation template Novotop Access Zinc plated + barretes	-	585 x 420 mm (23.03" x 16.54")		1 u.	-	NTOPFIJACM

# NOVONIVEL® ACCESS XT20



- Transition profile made of aluminum designed to avoid discontinuities in floorings such as low thickness ceramic , vinyl floorings or carpets.
- The profile has a wide and smoothed visible side with small grooved that favor the slide resistance.
- The lower part is reinforced for greater load support.
- Delivered with countersunk holes to improve its fixing by using screws (not included) or without it.
- Available in anodized aluminum silver matt color.
- Profiles supplied in standard lengths of 2.5 m (98.4”).

Novonivel® Access XT20

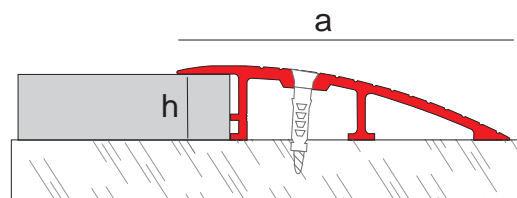

Material	h	a	Packaging	Color	REFERENCE
Aluminium	20 mm	100 mm	5 u.	Anod. matt silver	NNVALACPL20

# NOVONIVEL® ACCESS SLIMM

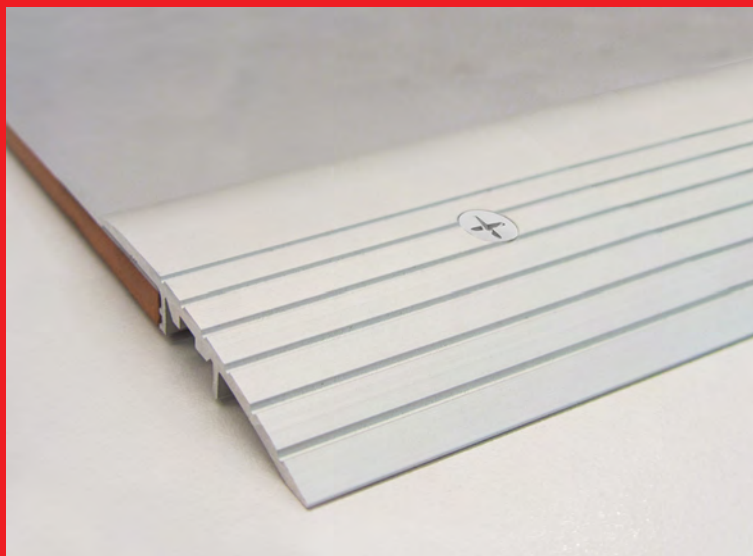

- Transition profile made of aluminum designed to avoid discontinuities in floorings such as low thickness ceramic , vinyl floorings or carpets.
- The profile has a wide and smoothed visible side with small grooved that favor the slide resistance.
- The inner part is reinforced to improve its load support.
- Delivered with countersunk holes to improve its fixing by using screws (not included).
- Available in anodized aluminum silver matt color.
- Profiles supplied in standard lengths of 2.5 m (98.4").

Novonivel® Access Slimm

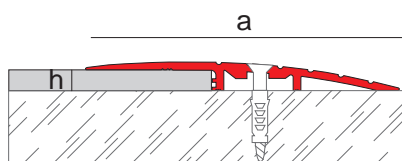

Material	h	a	Packaging	Color	REFERENCE
Aluminium with countersunk holes	5 mm (0.20")	60 mm (2.36")	15 u.	Anod. matt silver	NNVALACCP15
Aluminium without holes	5 mm (0.20")	60 mm (2.36")			NNVALACCP15S

# NOVONIVEL® ACCESS



- Transition profile made of aluminum designed to avoid discontinuities in floorings.
- The profile has a wide and smoothed visible side with small grooved that favor the slide resistance.
- The inner part is reinforced to improve its load support.
- Delivered with countersunk holes to improve its fixing by using screws (not included).
- Available in anodized aluminum silver matt color.
- Profiles supplied in standard lengths of 2.5 m (98.4").

Novonivel® Access

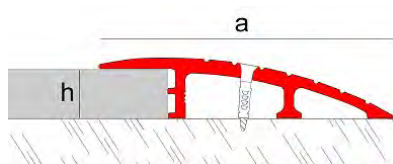

Material	h	a	Packaging	Color	REFERENCE
Aluminium	10 mm (0.39")	50 mm (1.97")	5 u.	Anod.matt silver	NNVALACCP10
	12 mm (0.47")	50 mm (1.97")			NNVALACCP12

# NOVONIVEL® FORTE



- A transition profile to avoid level differences of the pavement.
- With a broad, grooved, anti-slip surface and reinforced support base for greater load resistance.
- Novonivel® Forte helps to fulfill the DB-SUA document from CTE (Building Technical Code), contributing to save discontinuities less than 2" / 50 mm. with a slope less than 25%.
- It is available in matt silver.
- Profiles supplied in standard lengths of 2.5 m (98.4").

Novonivel® Forte

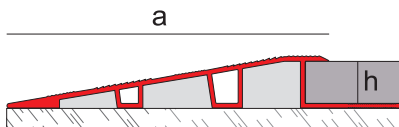

Material	h	a	Packaging	Colors	REFERENCE
Aluminium	12 mm (0.47")	96.4 mm (3.80")	10 u.	Matt silver	NNVFAL12PL25

# NOVOSTRIP - NOVOSTRIP SP

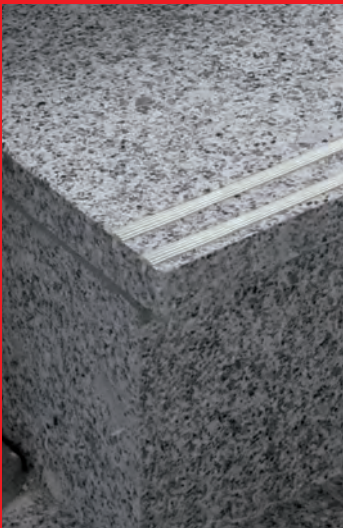

- Profile made of extruded aluminium intended to be installed in stairs, ramps or passage areas with marble, terrazzo or similar floorings, to guarantee safety against eventual falls.
- Very easy to install. You will only need to make a groove by using a marble saw cutter, and then insert the profile into it. It is recommendable reinforcing the installation with adhesive.
- It can be installed it with thinner floorings, like ceramics, by joining the tiles below the visible side.
- Due to its geometry and its small size, it can be installed alone or with other profiles forming a pattern.
- Profiles supplied in standard lengths of 2.5 m (98.4").

Novostrip



Novostrip SP

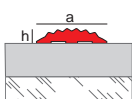

Modelo	Material	h	a	b	c	Packaging	Colors	REFERENCE
Novostrip	Aluminium	2,5 mm	9 mm	6 mm	2,8 mm	50 ud.	Natural	NSTRIPAL09NA
Novostrip SP		12 mm	2,5 mm	-	-	50 ud.	anod. Matt silver	NSTRIPALXLSP
				-	-	50 ud.	Champagne	NSTRIPALXLSPCH

# NOVOPLETINA® SAFETY



- Plate profile made of anodized aluminium, matt silver finish, with an insert of non-slip strip with different colors.
- This plate can be installed as a flooring separator, in entrances, stairs or ramps...
- The non-slip strip is classified as R13 according to the DIN 51130 standard.
- Available in four different colors: black, yellow, black/yellow, grey.
- Profiles supplied in standard lengths of 2.5 m (98.4").

Novopletina® Safety

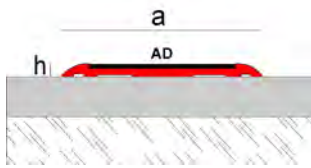

Width (a)	Strip width (ad)	Height (h)	Packaging	Length profile*	Strip color	REFERENCE
42 mm (1.66")	30 mm (1.81")	2.5 mm (0.1")	20 u.	2.5 m. (98.4")	black	NPLSFAL42NE
					grey	NPLSFAL42GR
					yellow	NPLSFAL42AM
					yellow/black	NPLSFAL42AN

# NOVOPLETINA LUMINA®



- Plate profile made of anodized aluminium with a photoluminescent strip that serves as a guide in case of sudden absence of light.
- It can be installed as a flooring separator, in entrances, stairs or ramps and also as a luminous guide in walls.
- The photoluminescent strip is classified as Class B according to Spanish UNE 23035-4 standard, and exceeds widely the values required
- It can be delivered with countersunk holes for screw attachment.
- Profiles supplied in standard lengths of 2.5 m (98.4").

Novopletina® Safety

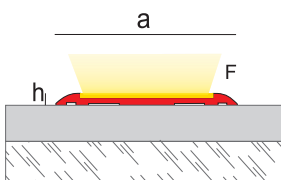

Width (a)	Strip width (ad)	Height (h)	Packaging	Length profile*	Strip color	REFERENCE
42 mm	30 mm	2.5 mm	20 u.	2.5 m.	light yellow	NPLLUAL42PL

## NOVOPLETINA® ALUMINIUM



- Striated plate profile made in anodized matt silver aluminum designed to be installed in stairs, ramps or in areas where the safety against falls wants to be assured.
- It supports intense traffic
- Acts as a guide for the blinded or partially sighted and also serves to signalize eventual dangers.
- This highly resistant profile is delivered with countersunk holes and is easy to install on finished floorings by using fixing screws.
- Profiles supplied in standard lengths of 2.5 m (98.4").

Novopletina® aluminium

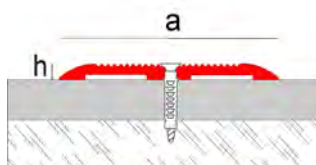

Profile height (h)	Visible width (a)	Packaging	REFERENCE
3 mm (0.12")	35 mm (1.40")	10 u.	NPLAL35PLAGU

## NOVOPLETINA® STAINLESS STEEL

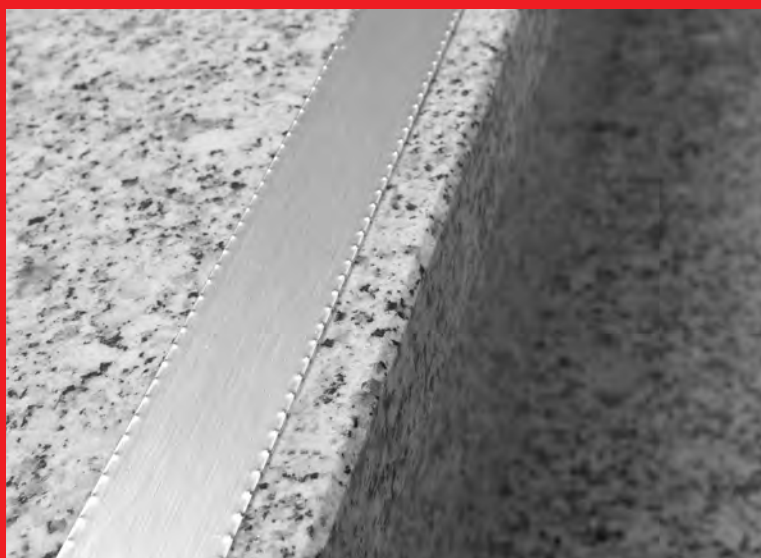

- Decorative plate made of stainless steel, suitable for its placement in ramps and as stair nosing.
- Its non-slip surface improves the value of slip resistance of the pavement which complements. This helps to fulfill with the Spanish Technical Building Code (CTE).
- It can be installed without work so it's ideal for rehabilitation or reform works. It is also ideal for public areas such as airports, malls, hospitals, etc. and for homes.
- It is available including adhesive. Ready to install.
- Available in stainless steel brushed. Covered with protective film.

Novopletina® stainless steel

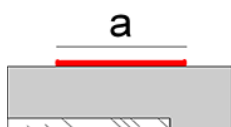

Material	Strip width (a)	Length profile	Packaging	Finish	REFERENCE
St. steel without adhesive	25 mm (1")	1/2 m (39.37 / 98.4")	50 u.	Brushed	NPLAI25CE*
St. steel with adhesive				Brushed	NPLAI25CE*A

\* Mark desired length among the available ones



# 16. TECHNICAL ENTRANCE MATS





# TECHNICAL ENTRANCE MATS



- The Novomat® entrance mats are an effective barrier to avoid the entry of dust, dampness and dirt, providing the maximum protection and durability to the flooring.
- Specially designed to contain dirt and prevent it from being tracked into the floors of public buildings: Airports, hospitals, hotels, offices, mall centres, shops, leisure venues...
- Its robust aluminium structure connected by high resistant synthetic rubber joints that avoid noises and prevent from sliding. This joint system allows the mat to be rolled easily and facilitates the evacuation of dust and moisture.
- Enabling commercial traffic and helping to save the accessibility standards for people with reduced mobility
- Disponibles en kit, con marco cortado a medida o bajo pedido con la geometría deseada y los complementos en opción. En acabados caucho o moqueta textil en gama de color.
- Available in standards size kit including frame cut to measure or under request they can be customize at the desired geometry. With two possible different finishes, rubber or carpet in different colours.

TO REQUEST  
BUDGET

## Novomat® custom made

- Novomat® 8 and Novomat® 12 have a larger aluminium visible side. They are reinforced and their striated visible side increases the non-slip value. Specially designed to be installed on already finished surfaces with the Novonivel® complement.
- Novomat® 15 and Novomat® 20 have a narrow design to get a perfect integration. These models are ideal for areas with high pedestrian traffic like shopping malls or any kind of public buildings. Due to its narrow design and the height of the profiles, these mats are more capable to retain the dirt, resulting in cost savings of cleaning and maintenance.

### Novomat® 8

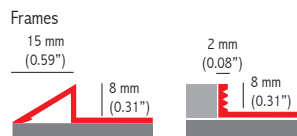
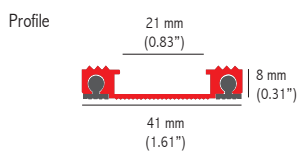

### Novomat® 12

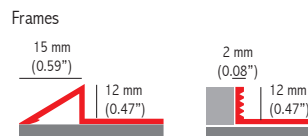
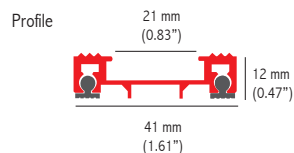

### Novomat® 15

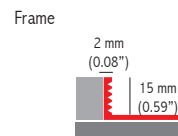
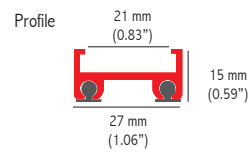

### Novomat® 20

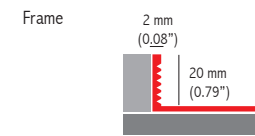
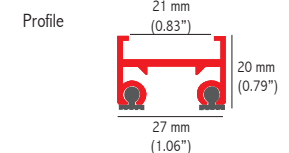

## COVERING: OUTDOOR:

- Black rubber: Suitable for covered outdoor installations. Can be combined with textile carpet.



rubber

## INDOOR:

- Textile carpet: 5 colors available: grey, anthracite, red, beige and tobacco. Suitable for indoor installations.



red

grey

beige

tobacco

anthracite



## Novomat® for wells

- Technical entrance mat wich includes the mat with its frame cut to size.

material	size	packaging	colour	Nº	code
Aluminio+ Moqueta Textil	1.198x0.881 m.	1 u.	grey	72	NM15MRG12X09

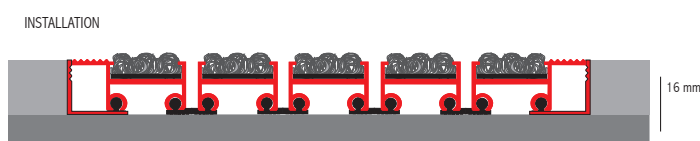
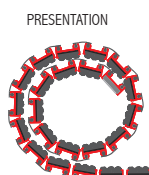
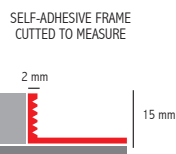
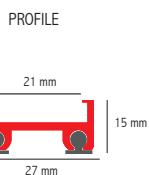
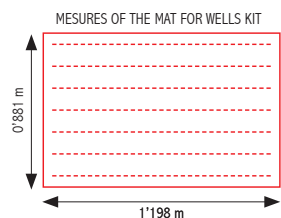

grey

Colours depicted in printed

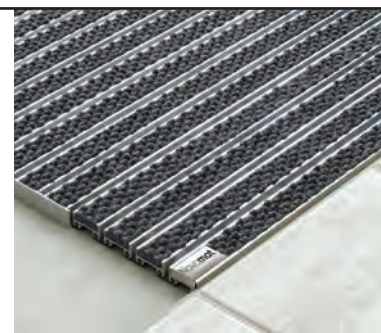

## Novomat® SlimM

- Technical entrance mat wich includes the mat with the self-adhesive frame cut to size.

material	size	packaging	colour	Nº	code
Aluminio+ Moqueta Textil	1,20x0,905 m	1 u.	grey	72	NM7MRG12X09

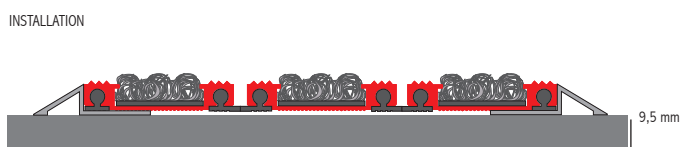
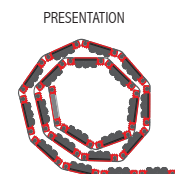
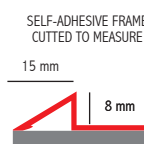
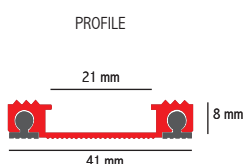
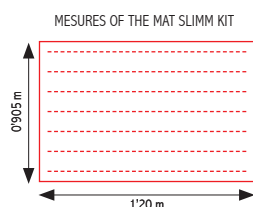

grey

Colours depicted in printed

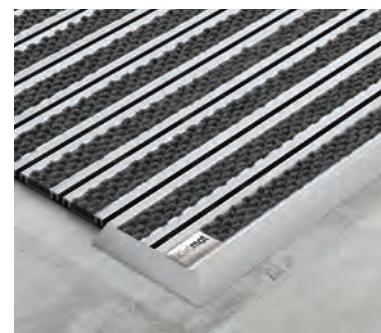

## Novomat® customized nameplate

- The technical entrance mats Novomat® have the possibility to be customized .This customization will give more visibility the brand and will provide a differentiating element at the entrance of your establishment. Easy installation.

material	size	packaging	colour	code
St. Steel	66 x 1980 mm	1 u.	brushed	NMPLAPER198A
	66 x 2980 mm			NMPLAPER298A
St. Steel	94 x 1980 mm	1 u.	brushed	NMPLASLM198A
	94 x 1980 mm			NMPLASLM298A

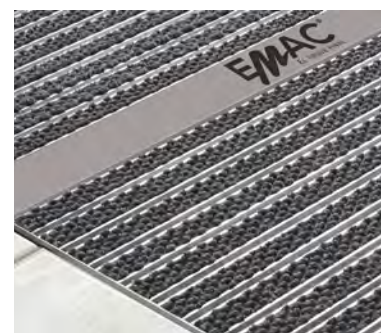

RECOMMENDATIONS								
MAT	INSTALLATION		TRAFFIC			OUTDOOR	INDOOR	CUSTOMIZATION
HEIGHT MM	SURFACE	WELL	LOW-MEDIUM	HIGH	HEAVY	RUBBER	TEXTILE CARPET	STAINLESS STEEL NAMEPLATE
Profile + rubber base	with perimeter ramp frame	with or without perimeter frame	houses, clinics, small shops...	office or administrative buildings	hospitals, universities, malls, airports...	for the retention of coarse dirt. To install before the entry	for the retention of fine dirt and moisture. Installation after the entry	Installation over news or already installed entrance mats
8	• NNVAL08NA25	• NSUAL08NA25	•			•	•	•
12	• NNVAL12NA	• NSUAL12NA25	•			•	•	•
15		• NSUAL15NA25	•	•		•	•	•
20		• NSUAL20NA25	•	•	•	•	•	•

## Novomat® Replacement strips

material	embalaje*	color	código
Moquette Textile	strip of 3 m	rubber	NMTIRACAUCHO
		grey	NMTIRAGRIS
		anthracite	NMTIRAANTRAC
		red	NMTIRAROJA
		beige	NMTIRABEIGE
		tobacco	NMTIRATABACO

## HOW TO REQUEST A NOVOMAT® ENTRANCE MAT?

Ask EMAC® for an entrance mat order form. There are two options:

### option A REGULAR SHAPES

1. Indicate the inside dimensions of the well or the mat dimensions (width A x depth B).
2. Indicate if the frame is needed.
3. Indicate if there are doors and their position in relation to the entrance mat.
4. Indicate the direction of the traffic flow.
5. Choose the height of the profile and the finish of the entrance mat.
6. Indicate if you want customized nameplate.

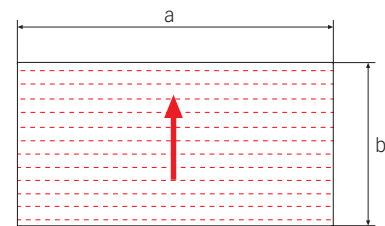

### option B IRREGULAR SHAPES

1. Do a drawing with the shape of the entrance mat and all its dimensions.
2. Indicate if the frame is needed.
3. Indicate if there are doors and their position in relation to the entrance mat.
4. Indicate the direction of the traffic flow.
5. Choose the height of the profile and the finish of the entrance mat.
6. A charge will be applied as appropriate depending on the features of the entrance mat requested
6. Indicate if you want customized nameplate.

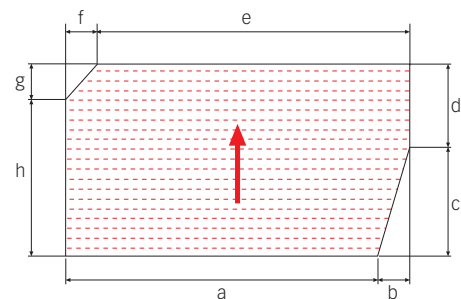

The maximum delivery length is 3 meters. For larger sizes, the entrance mats are made in several pieces. We recommend not requesting the joint in the central area, as it is the area with more traffic. The best option is leaving the joints between the pieces nearest to the sides.

material	size	code
Aluminium+ Textile carpet	h: 8 mm	NMAMH8MT
	h: 12 mm	NMAMH12MT
	h: 15 mm	NMAMH15MT
	h: 20 mm	NMAMH20MT
Aluminium+ Rubber	h: 8 mm	NMAMH8CN
	h: 12 mm	NMAMH12CN
	h: 15 mm	NMAMH15CN
	h: 20 mm	NMAMH120CN

Our technical team is at your total disposal to help you with the election and sizing of the entrance mat. For more information please contact [tecnico@emac.es](mailto:tecnico@emac.es)

# 17. DESIGN, DEVELOPMENT AND TECHNICAL SUPPORT



# EMAC<sup>®</sup> DESIGN AND DEVELOPMENT

EMAC<sup>®</sup> has its own R&D team that designs, develops and improves trims for the sole purpose of satisfying our customers' requirements. The EMAC<sup>®</sup> R&D department is made up of professionals with an extensive experience and excellent technical skills who are constantly learning and fully committed to the project. The team, backed by significant investment in collaboration with ground-breaking technology institutes, is able to provide technically competitive products of high quality.

The department has Rapid Prototyping Machine that allow us testing the models before its final development, reducing periods of execution and detect possible improvements. Once the products are manufactured, they are subjected to various tests that

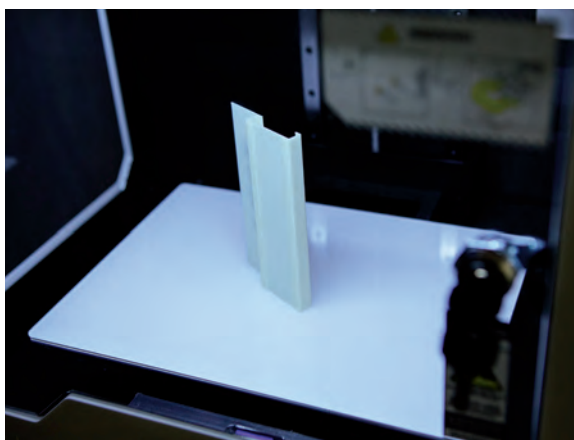

\*Rapid prototyping Machine

guaranty their maximum quality and functionality fulfilling the current normative.

In the past years, we have carried out tests of traction-compression, loading, corrosion, alloy compositions, slip resistance, stain resistance, abrasion resistance...

The careful choice of materials with which EMAC<sup>®</sup> profiles are manufactured is the main reason for the high quality of these products. Comprehensive tests are carried out, at EMAC<sup>®</sup> and/or Specialized Technical Intitutes, on their composition, strength, colour and other factors. EMAC<sup>®</sup> profiles are made

of high quality raw materials such as Stailes steel AISI 304, Aluminium (Qualicoat, Qualanoad), PVC, Maxi, methacrylate, wood or brass. Check the technical details of each material at the technical files of each product.

Investing in protecting our effort of Research, Development and Innovation through 550 patents and more than 30 proprietary names and brands by which our most popular product ranges are known. All of this is done in order to protect our products and the value of our brand, which is deeply consolidated in the market.

All of our products have their Technical File. Where you can find general information, technical details, tests carried out, methods for fitting them and guidelines for maintaining and cleaning each one of them. Pay special attention to the information contained in the Technical File to avoid damaging the products and to keep up proper maintenance.



# TECHNICAL SUPPORT

At EMAC® we want to help you carry out your Project by choosing always the best solutions. If you have any queries or requests about our products, do not hesitate to contact us at [tecnico@emac.es](mailto:tecnico@emac.es) and tell us about your project. Our technical department staff will assist you with professionalism and without delay. They are always at your disposal and without any compromise. We offer you our help with:

- Project plans: personalized and calculated study on the most suitable layout of expansion joints.
- Advise on rehabilitation and renovation works.
- Troubleshooting for structural joints.
- General enquiries: functionality, cleaning, fitting, etc. of our products



In our interest to share our knowledge and promote skills between the professionals in the sector, we have developed several technical documents that are at your disposal. At this Technical Documents, we cover topics of interest such as how to fit expansion joints on facades, the concept of slip and how it is applied according to the CTE standards, and supporting documents to choose the perfect EMAC® solution for expansion joints.

At the same time, to offer you a more detailed information you may find a Technical File for each product and material. In which you can find general information, technical details, tests carried out, methods for fitting them and guidelines for maintaining and cleaning each one of them. Pay special attention to the information contained in the Technical File to avoid damaging the products and to keep up proper maintenance.

You can download the Technical Files at our website [www.emac.es](http://www.emac.es), you can consult the information about each product at our online catalogue or ask for that information by e-mail at: [tecnico@emac.es](mailto:tecnico@emac.es).

# SOME MAJOR PROJECTS NATIONAL AND INTERNATIONAL WITH SOLUTIONS EMAC®



COMMERCIAL PREMISES

FOOD STORES

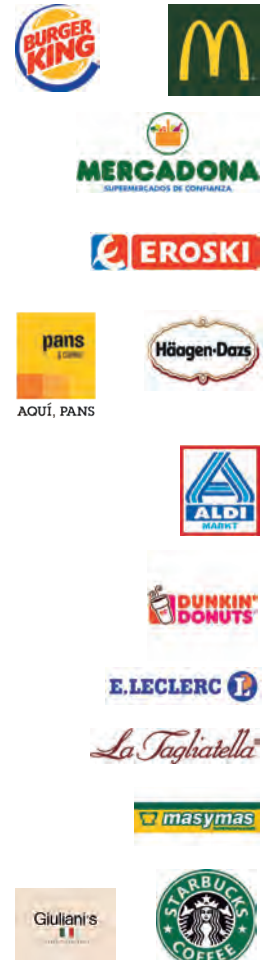

TEXTILE / FOOTWEAR

OTHER SECTORS





# APP EMAC<sup>®</sup> AUGMENTED REALITY



Try the new EMAC<sup>®</sup> APP

## Augmented Reality



Novojunta<sup>®</sup> Pro Metal 50

Download the EMAC<sup>®</sup> APP from Google Play and App Store





Tatami Rugby Club Valencia



Centro Ocupacional Quart de Poblet



Casa Caridad Valencia



Apival

Afaco



Fundación Vicente Ferrer

HEALTH

EDUCATION

SOCIAL INTEGRATION

SPORTS AND HEALTHY HABITS



EMAC® is a leading company in profiles and trims for wall and floor tiles, and expansion joint solutions for large projects. We offer more than 3.000 references in stock and excellent service, with solutions for floors, walls, facades and urban pavements. We are present in over 110 countries with subsidiaries in USA and Italy.

## PROJECTS

In the last 20 years, hundreds of projects worldwide have chosen our profiles for resolving their structural joint challenges. We present a few of them here.

Dublin Airport (Ireland), United Nations Communications Centre in Valencia (Spain), Algarve Race Circuit (Portugal), King Juan Carlos I University in Madrid (Spain), Guatemala International Airport, Ikea shopping center in A Coruña (Spain), Public Parking "Serrano Street" in Madrid (Spain), Jumeirah Beach Residence in Dubai (United Arab Emirates), kitchens of University Hospital of Getafe (Spain), Ágora Building in City of Arts and Sciences of Valencia (Spain).



Online Technical Catalog



**Technical & Decorative Profiles | Expansion Joints**

**Technical entrance mats | Universal Accessibility & Safety**

**EMAC® Group**

**Construction Division - EMAC®**

Valencia, **España** [www.emac.es](http://www.emac.es) | [tecnico@emac.es](mailto:tecnico@emac.es) | Tel. (+34) 961 532 200  
Miami (FL), **USA** [www.emac-america.com](http://www.emac-america.com) | [info@emac-america.com](mailto:info@emac-america.com) | Phone:#(305) 406 1593  
Sassuolo (Mo), **Italia** [www.emac-italia.it](http://www.emac-italia.it) | [info@emac-italia.it](mailto:info@emac-italia.it) | Tel. (+39) 0536994854

**Artistic Division – Artelux**

[www.arteluxcontract.com](http://www.arteluxcontract.com) | [www.artelux.es](http://www.artelux.es) | [projects@artelux.es](mailto:projects@artelux.es) Tel. (+34) 961 540 366

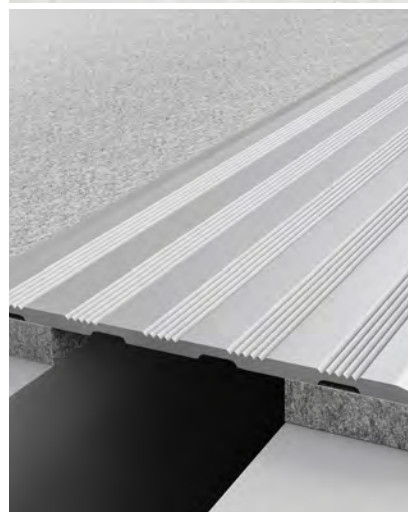
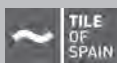

BIM solutions of EMAC®



Construction Price Viewer



Technical Guide of Universal Accessibility & Safety

