

# DICHIARAZIONE AMBIENTALE DI PRODOTTO – DAP/EPD

Secondo ISO 14025 y EN  
15804-2012+A2:2019 per:

PROFILI ANODIZZATI E DEI  
PROFILI LACCATI



EPD Program

Programme operator

CPC Code

Based on

Declaration number

Publication date

Revision date (\*)

Valid until

Market coverage

Representativeness

The International EPD® System

EPD International AB

41532 Bars, rods and profiles, of aluminium

PCR 2019:14 v1.0 Construction products and construction services. EPD System.

S-P-01409

2018-10-31

2020-04-27

2025-04-27

Worldwide

Spain

(\*) An EPD should provide current information and may be updated if conditions change. The stated validity is therefore subject to the continued registration and publication at [www.environdec.com](http://www.environdec.com)



EMAC<sup>®</sup> GRUPO è un'azienda leader nel mercato in **soluzioni per l'incontro dei vari materiali** che si danno appuntamento in un progetto costruttivo. La sua vasta gamma di **soluzioni per profilature tecniche e decorative, tappetini tecnici da ingresso, giunti di espansione e strutturali, oltre a soluzioni universali di accessibilità e sicurezza**, comprende pavimenti, pareti, facciate e pavimentazione per esterni in ambienti urbani, il tutto supportato da un servizio immediato unico nel suo settore.

EMAC<sup>®</sup> GRUPO è una **multinazionale di riferimento** formata da diverse aziende con presenza nel mercato nazionale ed internazionale. Opera in oltre 110 paesi, con **filiali negli U.S.A. e in Italia** per garantire la fornitura di soluzioni EMAC<sup>®</sup> ai clienti più esigenti nei mercati di tutto il mondo.

In EMAC<sup>®</sup> GRUPO, fedeli al nostro impegno per la sostenibilità, abbiamo sviluppato la **Dichiarazione ambientale di prodotto (DAP)** per i nostri prodotti in alluminio (nota anche come Environmental Product Declaration, EPD) che ci permette di valutare il ciclo di vita dei prodotti (LCA, o Life Cycle Assessment).

### Applicazioni

Il presente documento è una DAP settoriale. La DAP settoriale è rappresentativa di diversi fabbricanti.

Le applicazioni della presente DAP consistono in soluzioni in alluminio utilizzate principalmente in prodotti per **l'edilizia e la costruzione come profili**, finestre, porte, facciate continue, sistemi di facciata, lucernari, tende da sole, ecc.

### Prodotto

I prodotti coperti dalla presente DAP sono costituiti da profili estrusi in alluminio appartenenti alle famiglie **dei profili anodizzati e dei profili laccati**.

### Obiettivo e ambito di applicazione

La presente DAP **valuta i parametri ambientali della valutazione del ciclo di vita (LCA) e dell'inventario del ciclo di vita (Life Cycle Inventory, LCI)** della produzione di profili in alluminio da parte dei membri dell'Associazione spagnola dell'alluminio (Asociación Española del Aluminio, AEA), **durante l'intera vita utile del prodotto** con opzioni (smaltimento finale).

La presente DAP è la base per le comunicazioni business-to-business e può essere utilizzata da tutte le terze parti interessate nel settore delle costruzioni.



### Verifica

La presente DAP è conforme alla **norma ISO 14025** e ai requisiti stabiliti dalle regole di base della categoria di prodotto per **prodotti da costruzione 15804:2012+A2:2019** e dalle regole generali del programma **The International EPD<sup>®</sup> System**. I risultati riportati nella presente DAP si basano sulla relazione LCA per DAP settoriale dell'AEA, datata 12 aprile 2020 in conformità alla norma **ISO 14044**.

La verifica della presente DAP è stata effettuata dalla società esterna **Centro Tecnológico de Miranda de Ebro**.

### Validità

Con il supporto del nostro partner tecnologico **ITENE** (Istituto Tecnológico del Embalaje, Transporte y Logística) abbiamo ottenuto la convalida dalle **società di certificazione** dell'edilizia sostenibile **LEED e BREEAM che confermano** la validità della presente DAP, tenendo conto che **è d'obbligo specificare** che si tratta di **informazioni basate sui valori medi del settore** e che in nessun caso si può affermare che la DAP settoriale rappresenti esattamente un prodotto unico e concreto.

# ENVIRONMENTAL PRODUCT DECLARATION



S-P-01409

**GlobalEPD**

A VERIFIED ENVIRONMENTAL DECLARATION

GlobalEPD-IntEPD S-P-01409

In accordance with ISO 14025 and  
EN 15804-2012+A2:2019 for:

ANODIZED AND COATED  
ALUMINIUM PROFILES

**AEA**

Asociación Española del Aluminio  
y Tratamientos de Superficie



EPD Program

Programme operator

CPC Code

Based on

Declaration number

Publication date

Revision date (\*)

Valid until

Market coverage

Representativeness

The International EPD® System

EPD International AB

41532 Bars, rods and profiles, of aluminium

PCR 2019:14 v1.0 Construction products and construction services. EPD System.

S-P-01409

2018-10-31

2020-04-27

2025-04-27

Worldwide

Spain

# SUMMARY

AEA

Product

LCA  
Information

Results

Supplement  
Information

Verification

References

Contacts

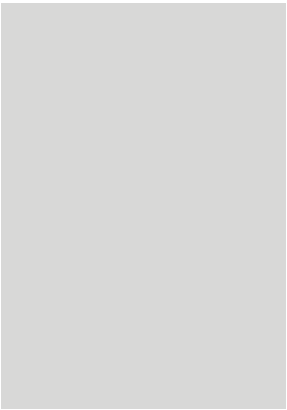

## ABOUT AEA

The Aluminium Spanish Association (Asociación Española de Aluminio – AEA) is a non-profit association that represents the Spanish aluminium industry and watches over the defense of its global interests.

The AEA is composed of 89 members, including extruders, lacquers and anodizers, as well as suppliers of quality services and raw materials such as primary and secondary aluminium, powder coating, thermal bridge break profiles (TBB) and chemical products for surface treatments.

The information in this document is based on data supplied by 12 AEA member companies who have produced a comprehensive industry-wide environmental product declaration (EPD) for anodized and coated aluminium profiles. The data comes from 17 separate production facilities, with a total of 38 extrusion presses, 13 anodizing lines, 20 coating lines and 1 cast house that produces secondary extrusion billet starting from post-industrial and consumer aluminium scrap. 3 of these 12 companies have own cast house to recycle the post-industrial aluminium scrap produced in their installations. Two manufacturers of polyamide profiles (TBB) and a manufacturer of chemical products (used in anodizing and coating) have also participated in the generation of the inventories. In aggregate, the data-contributing installations have a production capacity of more than 280.000 ton of aluminium profiles, about 74% of total AEA production and 62% of the total Spanish production.

## PARTICIPATING COMPANIES



[www.cortizo.com](http://www.cortizo.com)



[www.anodial.com](http://www.anodial.com)



[www.exlabesa.com](http://www.exlabesa.com)



[www.ensingerplastics.com](http://www.ensingerplastics.com)



[www.itesal.es](http://www.itesal.es)



[www.avalumitran.com](http://www.avalumitran.com)



[www.alsan.es](http://www.alsan.es)



[www.alueuropa.com](http://www.alueuropa.com)



[www.strugal.com](http://www.strugal.com)



[www.extol.es](http://www.extol.es)



[www.alasiberia.com](http://www.alasiberia.com)



[www.technoform.com](http://www.technoform.com)



[www.extrual.com](http://www.extrual.com)



[www.hydro.com](http://www.hydro.com)



[www.extrucolor.es](http://www.extrucolor.es)

# PRODUCT

## Product description

This EPD covers a wide range of aluminum extrusion products manufactured by AEA members in Spain, not considering a burden for scrap or credit for the EoL (End of Life). The products considered in this declaration are as follows:

- Anodized aluminium profile
- Coated aluminium profile
- Thermal break anodized aluminium profile
- Thermal break coated aluminium profile

It excludes downstream fabrication operations such as machining and assembly due to the wide diversity of such operations.

The results are an average representative of all aluminium profiles produced for AEA members. Averages are obtained through aggregating production-weighted data from the participating companies. For this reason, EPD covers average values and declared products are an average that is not available for purchase on the market.

## Applications

Aluminium profiles are primarily used in building and construction applications, including windows, doors, curtain walls, façade systems, skylights, canopies, etc.

## Technical data

Technical data is representative of 6000 series aluminium alloys (6xxx alloy, tempers T1-T6), which is the predominant production of the participants.

## Composition

Aluminium profiles can be produced as standard or customer design so there is a wide variety of profiles. Therefore, the composition of the final product can also be very different between designs. This EPD covers four product groups with an average composition as shown below. The product does not contain any substance included in the list of Substances of Very High Concern with concentrations higher than 0.1% in weight.

## Packaging

Aluminium profiles are packaged using lumber, plastic film, plastic strapping and cardboard. Packaging is often per customer specification. All packaging materials are recyclable and/or reusable following delivery to the customer. Packaging materials are included in the scope of this EPD (in A1 module); packaging disposal and raw materials packaging, however, are outside the scope.

Property	Value
Young's modulus	68 - 80 GPa UNE-EN ISO 6892
Yield strength (elastic limit)	95 - 610 Mpa UNE-EN ISO 6892
Tensile strength	180 - 620 Mpa UNE-EN ISO 6892
Hardness - Vickers	60 - 160 HV UNE-EN ISO 6507
Fatigue strength (10 <sup>7</sup> cycles)	57 - 210 Mpa UNE 7118
Density	2550 - 2900 kg/m <sup>3</sup>
Melting point	495 - 640 °C
Thermal conductivity	118 - 174 W/m.°C
Specific heat capacity	890 - 1020 J/kg.°C



The biogenic carbon contained in the wood and cardboard used in the packaging represents a total of 0.023 kg per each kilogram of aluminium profile.

### Reference service life and use phase

Service life for products will vary depending on the final application, but is typically long due to aluminium's high corrosion resistance. It can accept a service life of 50 years according to bibliography. Similarly, further processing (other than anodizing, coating, or thermal improvement), assembly and/or installation of extruded aluminum products are outside the scope of this EPD.

### Recycling and disposal

Aluminium products are highly recyclable. During aluminium profile production, all post-industrial scrap (extrusion drop-offs from cutting, unfit material and discards, etc.) is fed back into the billet production process. Even some AEA members operate their own scrap smelting facilities in addition to purchasing billet from external secondary smelters or from primary aluminium manufacturer.

In the same way, when an aluminium building product reaches the end of its life, it is systematically and selectively collected and sent to recycling facilities for secondary billet production. A collection rate for aluminium products next to 95% is well documented in construction sector.



	ANODIZED PROFILE	COATED PROFILE	THERMAL BREAK ANODIZED PROFILE	THERMAL BREAK COATED PROFILE
<b>Aluminium profile</b>	<b>1.000kg</b>	<b>0.952kg</b>	<b>0.878kg</b>	<b>0.830kg</b>
Aluminium			93-96%	
Magnesium			0.5-1.5%	
Silicon			0.5-1.5%	
Others			<0.2%	
Post-consumer material			27%	
Pre-consumer material			12%	
Renewable material			0%	
Biogenic carbon			0%	
<b>Coating (polyester)</b>	<b>-</b>	<b>0.048kg</b>	<b>-</b>	<b>0.048kg</b>
Post-consumer material			0%	
Renewable material			0%	
<b>Thermal Break</b>	<b>-</b>	<b>-</b>	<b>0.122kg</b>	<b>0.122kg</b>
Polyamide	-	-	75%	75%
Glass fiber	-	-	25%	25%
Post-consumer material			0%	
Renewable material			0%	
<b>Packaging</b>			<b>0.065kg</b>	
Wood			0.039kg - 3.9% (*)	
Cardboard			0.014kg - 1.4% (*)	
Polyester			0.002kg - 0.2% (*)	
Plastic Film			0.010kg - 1.0% (*)	
Biogenic carbon			0.023kg C	

(\*) Versus product

In both cases recycling rate depends on smelting yield that includes metal losses during scrap preparation and melting. Smelting yield is highly influenced by the presence of non aluminium material (as TBB and/or coating) and the origin of the scrap (post-industrial or post-consumer).

Hence, aluminium supply at the beginning of the product system has a content of recycled material from post-industrial and post-consumer scrap with the consequent reduction of environmental burdens. In module D are reported only the net benefits of recycling, i.e. the recycling benefits at the end of life minus the benefits already considered in the module A1 due to secondary aluminium content. In this EPD, the scrap not collected at the end of life is sent to landfill. The average metal composition, based on metal feedstock information collected from the companies participating in this EPD, is shown in the composition table.

### System boundaries

The scope of the study is set to be “Cradle-to-gate with options”. Processes included in the assessment are presented on the diagram below.

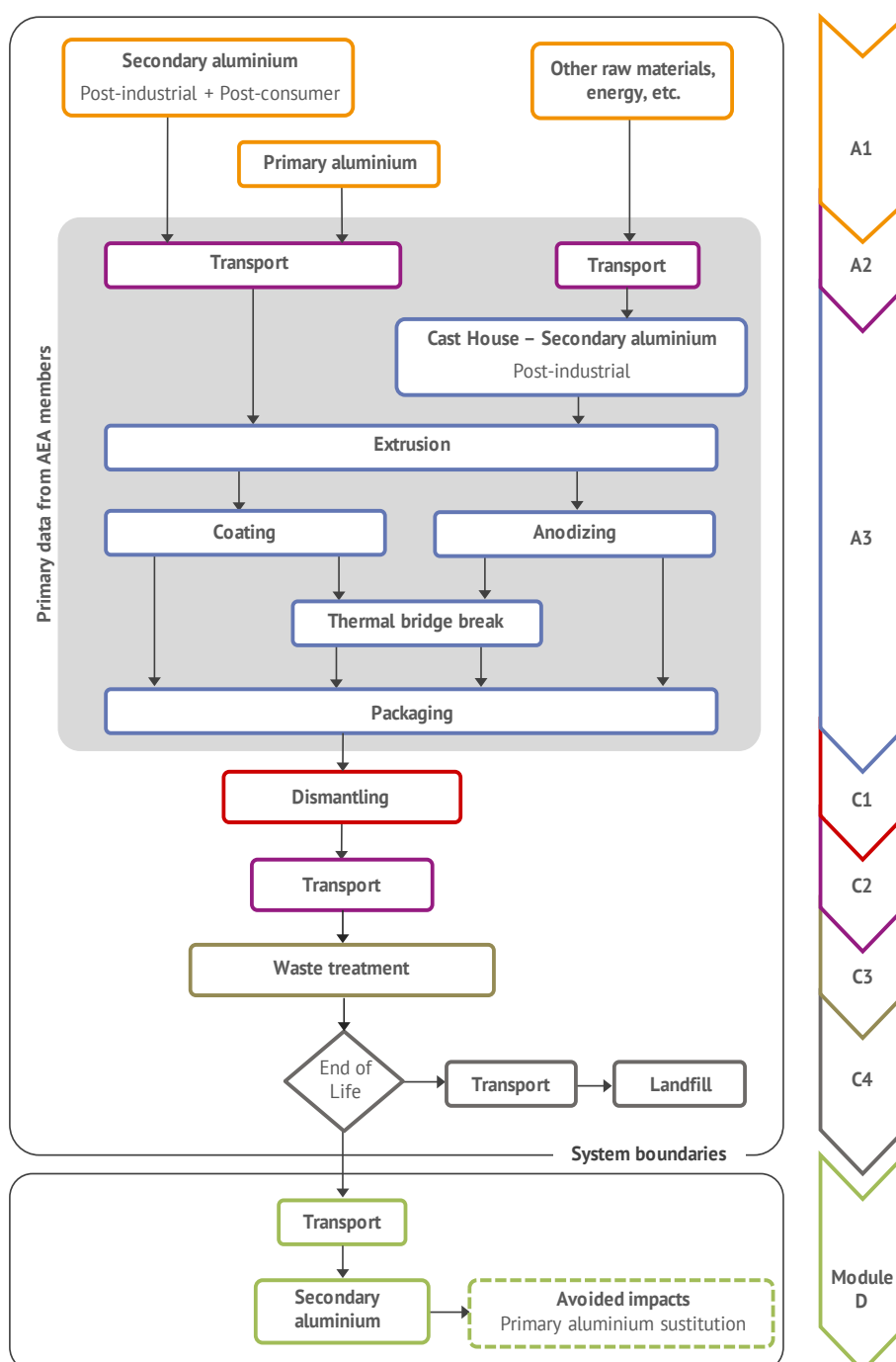



# LCA INFORMATION

## Declared unit

The declared unit is the production of 1 kg of aluminium profile for construction use including the surface treatment (coating or anodization) and the optional thermal bridge break.

To obtain the environmental information referred to a 1 meter of profile, conversion factors are provided for 4 products: anodized profile, 0.592 kg/m; thermal break anodized profile, 0.550 kg/m; coated profile, 0.576 kg/m; and thermal break coated profile, 0.534 kg/m.

## Goal and scope

This EPD evaluates the environmental impacts of 1 kg aluminium profile product from cradle to gate with option (disposal). This EPD is the basis for B2B communication. Intended use clients and relevant stakeholders within the building sector.

## System boundaries

This EPD provides information on the production stage of the aluminium profiles (raw material supply, transport to plants and manufacturing) and their end-of-life. Recycling potential of aluminium with burdens saving due to use in a second product systems is also reported. The information is presented in a modular way separated in the following stages.

Stage	Production			Construction		Use							End-of-life				Resource recovery
	Raw materials supply	Transport	Manufacturing	Transport	Installation	Use	Maintenance	Repair	Replacement	Refurbishment	Operational energy use	Operational water use	De-construction	Transport	Waste processing	Disposal	
Module	A1	A2	A3	A4	A5	B1	B2	B3	B4	B5	B6	B7	C1	C2	C3	C4	D
Declared module	X	X	X	ND	ND	ND	ND	ND	ND	ND	ND	ND	X	X	X	X	X
Geography	EU	EU	EU	-	-	-	-	-	-	-	-	-	EU	EU	ES	EU	EU
Specific data	94.3%			-	-	-	-	-	-	-	-	-	-	-	-	-	-
Variation - products <sup>(1)</sup>	+12.8% / -7.6%			-	-	-	-	-	-	-	-	-	-	-	-	-	-
Variation - plants <sup>(2)</sup>	+12.8% / -7.6%			-	-	-	-	-	-	-	-	-	-	-	-	-	-

(1) Maximum variation for all declared products - (2) Maximum variation for all manufacturers  
 ND - Not declared

### A1-3 - Cradle to gate

The aggregation of the modules A1, A2 and A3 is allowed by EN 15804. This rule is applied in this EPD and denoted by A1-3. This module represents the extraction and processing of raw materials, the transport to production sites and the manufacture and packaging of profiles.

### C1 - De-construction

No information was found in the life cycle databases consulted for the dismantling operations of elements such as windows or external doors, nor was there a bibliography regarding the inputs or residues generated during these operations. Then, there is no contribution on impact categories of this module.

### C2 - Transport to waste processing

A distance of 200 km has been assumed for the transport to scrap dealers. Transport is calculated on the basis of a scenario with the parameters described in the attached table.

### C3 - Waste processing for reuse, recovery and/or recycling

It has been assumed that during the scrapping operations the same electricity is consumed as during the assembly of a window of 1.23 mx 1.48 m with a profile thickness between 45 and 70 mm.

### C4 - Final disposal

Recovery rates for aluminium during building dismantling are modelled based on figures reported by the European Aluminium Association (see references). It was assumed a 95% for recovery rate while the remaining 5% goes to landfill.

### D - Allocation by reuse, recovery or recycling

Scrap inputs to the production stage are subtracted from scrap to be recycled at end of life in order to obtain the net scrap output from the product system. This remaining net scrap is then sent to recycling. Module D report the environmental aspects of recycled scrap generated at the end of life minus that used at the production stage. Loads and benefits are assessed at the point of functional equivalence, i.e. where the substitution of primary aluminium takes place. In the recycling process, smelting yield for each scrap fraction was taken into account.

In order to make the results tables lighter, will be shown only declared modules with a non-zero contribution to the impact categories declared in this EPD.

## Time representativeness

All primary data used in this EPD are based on the 2017 production data for aluminium profiles manufactured by AEA members in their facilities in Spain.

## Database(s) and LCA software used

The data for primary aluminium billet and for scrap remelting (secondary aluminium billet) are based on LCI dataset published by European Aluminium in february 2018 and are the best available. For transport processes the ELCD 3.2 database was consulted. Other LCI datasets were sourced from the Ecoinvent v3.3.

Parameters, C2 module	
Transport by road <sup>(1)</sup>	Lorry, 17.3 t max payload
Diesel consumption (l/km)	0.221
Distance (km)	200
Volume capacity utilization	100%
Mass capacity utilisation	67%

(1) Technology mix, Euro 0, 1, 2, 3, 4

Parameters, C3 module	
Energy carrier	Electricity, low voltage {ES}
Consumption (kWh/kg)	0.0245
Waste (landfill)	0.05 kg

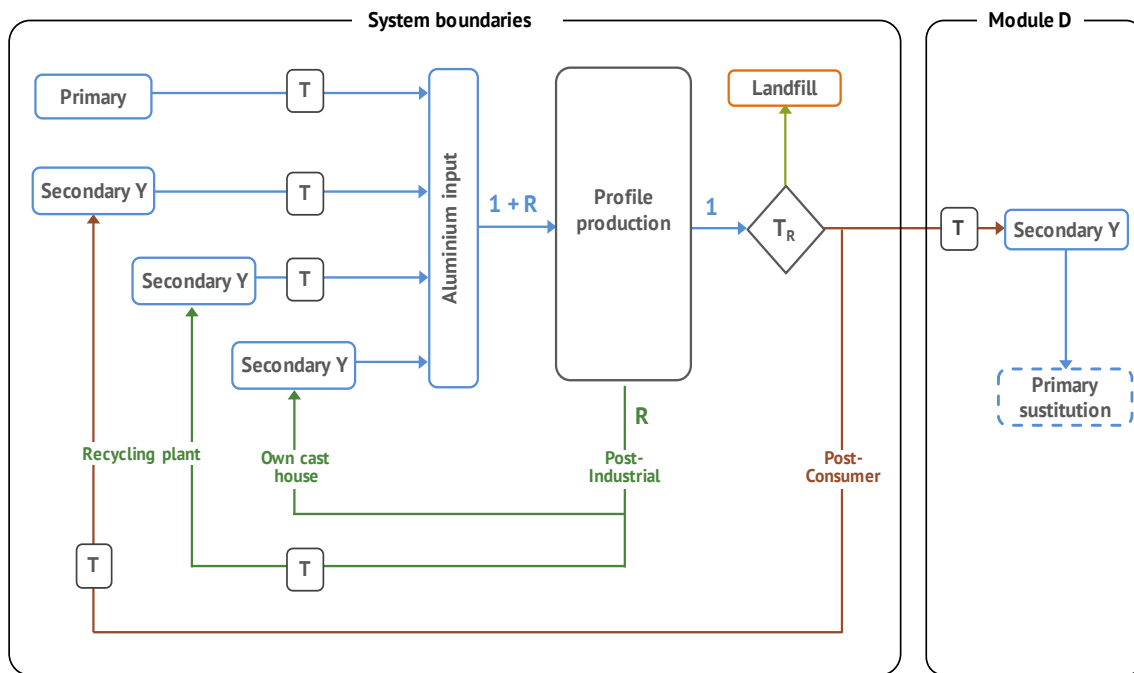

R – Process losses     $T_R$  – Recovery Rate    Y – Smelting yield    T - Transport

The LCA study was performed using an excel-based model. The impact assessment results were calculated using characterization factors from EC-JRC available at <http://eplca.jrc.ec.europa.eu/LCDN/developerEF.xhtml>.

## Data Quality

In order to achieve precision, consistency and representativeness and to ensure reliable results, first-hand industry data were used. All foreground data were collected from AEA participating companies for their facilities using customized data collection templates. It was created representative production-weighted inventories. These inventories are intended to represent average of aluminium profile production for building by AEA members. The age of these data is less than two years. As for bibliographic data, none has been used with a year of publication lower than 2011.

Regionally specific datasets were used to model the energy consumption (electricity, natural gas or diesel). For the processes of transport, production of raw materials or end-of-life, datasets were chosen according to their technological and geographical representation of the actual process. The technological and geographical representativeness of 76% of the processes included in the LCA is guaranteed, among which are the most contributing to final results. For 18% of the processes, only geographical or technological representativeness is guaranteed. For the rest of the processes, proxy datasets were used to address the lack of data for a specific process or for a specific geographical region.

## Estimates and Assumptions

The activity data was obtained from inventories that were completed by all the participating companies based on their data on production, consumption of raw materials and energy, and the generation of waste, effluents and emissions. From these inventories, a unitary process was generated for each manufacturer and for each of the phases of the profile manufacturing process. Finally, the unit processes that support this EPD were obtained from the weighted average of the unit processes of all manufacturers for the same phase of the manufacturing process.

The maximum and minimum values for module A1-3 have been obtained from the individual evaluation for each of the manufacturers that have provided inventories. In those cases in which the manufacturers could not complete all

the environmental aspects that have been included in the calculation of the impacts, the weighted average value of these environmental aspects has been used. In this way, the integrity of all inventories is guaranteed, making the comparison between them more consistent with the ultimate aim of obtaining maximum and minimum values. At this point it is noteworthy that in most cases, the inventories provided by manufacturers present the most relevant environmental aspects (consumption of energy or main raw materials), being necessary to complete them with those with a lower incidence on the final result.

It was not possible to distinguish the consumption of electricity and natural gas between the production stages of profiles. Based on the total energy consumption in the plants, electricity and natural gas used in the different stages was estimated under the criteria of the technical staff of plants. Total energy consumption was attributed entirely to extrusion, coating, anodizing and cast house. The contribution of packaging and thermal bridge break to electricity consumption is not relevant (but it is included in the rest of processes).

Once the energy consumption was attributed to extrusion, coating, anodizing and cast house, it was apportioned among the total production of semi-finished products for each stage. It has proceeded in the same way for raw materials and waste generation.

Because tens of different chemicals are used for surface treatments before anodizing and coating, their consumption were modeled based on the surface of an average profile. The surface treatments chosen are the most complete and those that require the use of the greatest amount of chemicals per square meter of treated surface, thus attending to a conservative assumption.

Billets are made from 100% primary aluminium or nearly 100% secondary aluminium (from post-industrial and post-consumer scrap). Billet manufacturers have provided production data for both in order to calculate the recycled content in the aluminum input to the product system.

All scrap was modeled as burden free when entering the system but it was included transport to the recycling sites for post-industrial scrap from AEA members.

## **EPD updating**

New standard EN 15804-2012+A2:2019 has meant important methodological changes in the development of EPD of construction products that have led to the writing of new PCR by the International EPD® System. For this reason, AEA, which is making a decisive commitment to environmental innovation, has faced the update of its sector EPD of aluminium profiles.

The main change made in this update has been the declaration of the new list of indicators, basic and additional. These changes affect the number of these indicators, the new units in which some of them are expressed and the new characterization factors applied. Although the environmental indicators cannot be compared between different versions of the EPD, especially when there are such deep changes between them, a reduction in impacts such as climate change or energy parameters has been observed.

As it is a sector EPD, the maximum and minimum variation of all indicators has been declared. This range contains the variation due to the different products represented by average product, and due to the different production facilities included in the study. Another issue of interest in the update is that packaging components of the profiles, and their biogenic carbon content, have been declared.

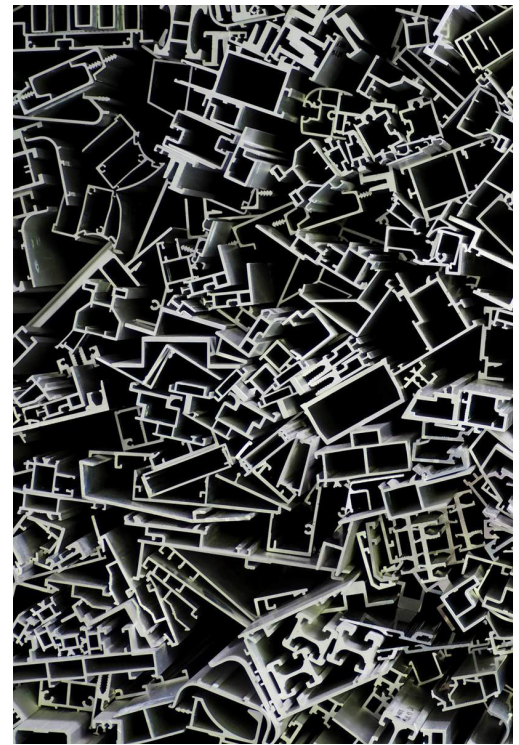

# RESULTS

## ANODIZED ALUMINIUM PROFILE

BASIC ENVIRONMENTAL IMPACTS		UNIT	A1-3	C2	C3	C4	D	A1-3 min	A1-3 máx
CC-2013	kg CO <sub>2</sub> eq	8,54	1,31E-02	1,07E-02	3,39E-03	-3,98	7,90	9,54	
CC-total	kg CO <sub>2</sub> eq	8,64	1,33E-02	1,14E-02	3,69E-03	-3,99	7,98	9,67	
CC-fossil	kg CO <sub>2</sub> eq	8,63	1,33E-02	1,13E-02	3,68E-03	-3,98	7,97	9,66	
CC-biogenic	kg CO <sub>2</sub> eq	4,10E-03	0	9,16E-06	7,52E-07	-9,50E-04	3,53E-03	4,69E-03	
CC-luluc	kg CO <sub>2</sub> eq	6,33E-03	0	4,18E-05	2,00E-07	-7,40E-04	5,43E-03	8,64E-03	
OD	kg CFC-11 eq	4,08E-07	2,04E-11	1,32E-09	7,72E-11	-3,00E-11	3,46E-07	5,23E-07	
A	mol H <sup>+</sup> eq	6,20E-02	8,89E-05	8,84E-05	6,31E-06	-2,33E-02	5,77E-02	6,69E-02	
EAF	kg PO <sub>4</sub> <sup>-3</sup> eq	3,43E-03	1,43E-05	1,39E-05	4,82E-05	0	3,03E-03	4,00E-03	
EAM	kg N eq	7,74E-03	4,20E-05	1,23E-05	6,39E-06	-3,38E-03	7,04E-03	8,35E-03	
ET	mol N eq	8,28E-02	4,60E-04	1,26E-04	2,53E-05	-3,68E-02	7,54E-02	8,90E-02	
POF	kg NMVOC eq	2,38E-02	1,17E-04	3,52E-05	6,98E-06	-1,01E-02	2,17E-02	2,60E-02	
AD-non fossil	kg Sb eq	1,19E-05	5,24E-10	7,59E-09	6,42E-10	-9,00E-07	1,12E-05	1,47E-05	
AD-fossil	MJ	122	0,186	0,213	1,38E-02	-49,2	113	142	
WU	m <sup>3</sup> eq	1,37	5,06E-05	3,28E-03	2,41E-03	-0,426	1,19	1,90	

ADDITIONAL ENVIRONMENTAL IMPACTS		UNIT	A1-3	C2	C3	C4	D	A1-3 min	A1-3 max
PM	Disease incidence	5,60E-07	7,68E-10	1,77E-10	4,84E-11	-3,26E-07	5,23E-07	5,95E-07	
IR	kBq U235 eq	1,31	3,24E-05	4,79E-03	4,18E-05	-0,560	1,21	1,45	
EF	CTUe	28,5	4,26E-04	7,69E-02	0,551	-0,177	26,0	31,8	
HT-c	CTUh	1,65E-07	6,89E-12	3,64E-10	2,25E-10	-6,43E-09	1,34E-07	2,37E-07	
HT-nc	CTUh	1,29E-06	4,17E-11	1,60E-09	5,76E-09	-1,65E-07	1,23E-06	1,38E-06	
LU	Dimensionless	32,0	0	8,30E-02	8,84E-03	-0,934	14,2	65,3	

**ENVIRONMENTAL IMPACTS.** **CC-2013:** Climatic Change according to EN 15804:2012+A1:2013; **CC-total:** Climatic Change - total; **CC-fossil:** Climatic Change - fossil; **CC-biogenic:** Climate change - biogenic; **CC-luluc:** Climate change - land use and land use change; **OD:** Ozone depletion; **A:** Acidification ; **EAF:** Eutrophication aquatic freshwater; **EAM:** Eutrophication aquatic marine; **ET:** Eutrophication terrestrial; **POF:** Photochemical ozone formation; **AD- non fossil:** Abiotic resource depletion - minerals and metals; **AD-fossil:** Abiotic resource depletion - fossils; **WU:** Water use; **PM:** Particulate matter emissions; **IR:** Ionising radiation; **EF:** Ecotoxicity - freshwater; **HT-c:** Human toxicity, cancer effects; **HT-nc:** Human toxicity, non-cancer effects; **LU:** Land use.

## ANODIZED ALUMINIUM PROFILE

RESOURCE USE	UNIT	A1-3	C2	C3	C4	D	A1-3 min	A1-3 max
PERE	MJ	34,2	0	0	0	-22,3	31,8	35,8
PERM	MJ	1,82E-04	0	0	0	0	1,09E-04	2,64E-04
PERT	MJ	34,2	0	0	0	-22,3	31,8	35,8
PENRE	MJ	80,1	0	0	0	-49,0	74,7	83,7
PENRM	MJ	4,54E-04	0	0	0	0	2,72E-04	6,61E-04
PENRT	MJ	80,1	0	0	0	-49,0	74,7	83,7
SM	kg	0,412	0	0	0	0,488	0,408	0,417
RSF	MJ	7,27E-04	0	0	0	0	4,35E-04	1,06E-03
NRSF	MJ	8,18E-04	0	0	0	0	4,89E-04	1,19E-03
FW	m <sup>3</sup> eq	0,278	0	0	0	-0,174	0,257	0,306
WASTE CATEGORIES	UNIT	A1-3	C2	C3	C4	D	A1-3 min	A1-3 max
HWD	kg	0,400	0	0	0	-0,258	0,371	0,419
NHWD	kg	2,19	0	0	6,00E-03	-1,20	1,81	2,29
RWD	kg	5,85E-03	0	0	0	-2,93E-03	5,05E-03	6,54E-03
OUTPUT FLOWS	UNIT	A1-3	C2	C3	C4	D	A1-3 min	A1-3 max
CRU	kg	1,27E-03	0	0	0	0	7,61E-04	1,85E-03
MFR	kg	0,239	0	0	0	0	0,149	0,304
MER	kg	1,45E-03	0	0	0	0	8,69E-04	2,12E-03
EE	MJ	1,54E-03	0	0	0	0	9,24E-04	2,25E-03

**RESOURCE USE.** **PERE:** Renewable primary energy as energy carrier; **PERM:** Renewable primary energy resource as material utilization; **PERT:** Total use of renewable primary energy resources; **PENRE:** Non-renewable primary energy as energy carrier; **PENRM:** Non-renewable primary energy as material utilization; **PENRT:** Total use of non-renewable primary energy resources; **SM:** Use of secondary materials; **RSF:** Use of renewable secondary fuels; **NRSF:** Use of non-renewable secondary fuels; **FW:** Use of net fresh water.

**WASTE CATEGORIES.** **HWD:** Hazardous waste disposed; **NHWD:** Non-hazardous waste disposed; **RWD:** Radioactive waste disposed.

**OUTPUT FLOWS.** **CRU:** Components for re-use; **MFR:** Materials for recycling; **MER:** Materials for energy recovery; **EE:** Exported energy per energy carrier.



## COATED ALUMINIUM PROFILE

BASIC ENVIRONMENTAL IMPACTS		UNIT	A1-3	C2	C3	C4	D	A1-3 min	A1-3 max
CC-2013	kg CO <sub>2</sub> eq	7,76	1,31E-02	1,07E-02	4,39E-03	-3,48	7,17	8,76	
CC-total	kg CO <sub>2</sub> eq	7,84	1,33E-02	1,14E-02	4,76E-03	-3,48	7,24	8,87	
CC-fossil	kg CO <sub>2</sub> eq	7,83	1,33E-02	1,13E-02	4,76E-03	-3,48	7,23	8,86	
CC-biogenic	kg CO <sub>2</sub> eq	3,38E-03	0	9,16E-06	1,05E-06	-8,29E-04	2,93E-03	4,00E-03	
CC-luluc	kg CO <sub>2</sub> eq	6,32E-03	0	4,18E-05	2,80E-07	-6,46E-04	5,60E-03	8,76E-03	
OD	kg CFC-11 eq	2,39E-07	2,04E-11	1,32E-09	1,03E-10	-2,62E-11	1,94E-07	4,36E-07	
A	mol H <sup>+</sup> eq	4,56E-02	8,89E-05	8,84E-05	7,09E-06	-2,03E-02	4,20E-02	5,00E-02	
EAF	kg PO <sub>4</sub> <sup>-3</sup> eq	2,06E-03	1,43E-05	1,39E-05	5,93E-05	0	1,77E-03	2,74E-03	
EAM	kg N eq	6,93E-03	4,20E-05	1,23E-05	7,86E-06	-2,95E-03	6,36E-03	7,49E-03	
ET	mol N eq	7,44E-02	4,60E-04	1,26E-04	2,80E-05	-3,21E-02	6,83E-02	8,00E-02	
POF	kg NMVOC eq	2,13E-02	1,17E-04	3,52E-05	7,78E-06	-8,85E-03	1,97E-02	2,35E-02	
AD-non fossil	kg Sb eq	5,16E-06	5,24E-10	7,59E-09	8,81E-10	-7,85E-07	4,60E-06	8,32E-06	
AD-fossil	MJ	108	0,186	0,213	1,53E-02	-42,9	101	128	
WU	m <sup>3</sup> eq	1,30	5,06E-05	3,28E-03	3,37E-03	-0,372	1,15	1,85	
ADDITIONAL ENVIRONMENTAL IMPACTS		UNIT	A1-3	C2	C3	C4	D	A1-3 min	A1-3 max
PM	Disease incidence	5,23E-07	7,68E-10	1,77E-10	5,83E-11	-2,84E-07	4,83E-07	5,48E-07	
IR	kBq U235 eq	1,04	3,24E-05	4,79E-03	5,08E-05	-0,489	0,96	1,16	
EF	CTUe	11,1	4,26E-04	7,69E-02	0,767	-0,155	9,5	15,3	
HT-c	CTUh	1,49E-07	6,89E-12	3,64E-10	2,46E-10	-5,61E-09	1,19E-07	2,30E-07	
HT-nc	CTUh	5,12E-07	4,17E-11	1,60E-09	8,00E-09	-1,44E-07	4,58E-07	6,09E-07	
LU	Dimensionless	28,7	0	8,30E-02	1,24E-02	-0,815	10,6	62,5	

**ENVIRONMENTAL IMPACTS.** **CC-2013:** Climatic Change according to EN 15804:2012+A1:2013; **CC-total:** Climatic Change - total; **CC-fossil:** Climatic Change - fossil; **CC-biogenic:** Climate change - biogenic; **CC-luluc:** Climate change - land use and land use change; **OD:** Ozone depletion; **A:** Acidification ; **EAF:** Eutrophication aquatic freshwater; **EAM:** Eutrophication aquatic marine; **ET:** Eutrophication terrestrial; **POF:** Photochemical ozone formation; **AD- non fossil:** Abiotic resource depletion - minerals and metals; **AD-fossil:** Abiotic resource depletion - fossils; **WU:** Water use; **PM:** Particulate matter emissions; **IR:** Ionising radiation; **EF:** Ecotoxicity - freshwater; **HT-c:** Human toxicity, cancer effects; **HT-nc:** Human toxicity, non-cancer effects; **LU:** Land use.

## COATED ALUMINIUM PROFILE

RESOURCE USE	UNIT	A1-3	C2	C3	C4	D	A1-3 min	A1-3 max
PERE	MJ	32,8	0	0	0	-19,4	30,4	34,1
PERM	MJ	1,74E-04	0	0	0	0	1,04E-04	2,58E-04
PERT	MJ	32,8	0	0	0	-19,4	30,4	34,1
PENRE	MJ	76,8	0	0	0	-42,8	71,2	79,9
PENRM	MJ	4,36E-04	0	0	0	0	2,59E-04	6,44E-04
PENRT	MJ	76,8	0	0	0	-42,8	71,2	79,9
SM	kg	0,395	0	0	0	0,426	0,385	0,402
RSF	MJ	6,97E-04	0	0	0	0	4,15E-04	1,03E-03
NRSF	MJ	7,84E-04	0	0	0	0	4,67E-04	1,16E-03
FW	m <sup>3</sup> eq	0,264	0	0	0	-0,152	0,243	0,277

WASTE CATEGORIES	UNIT	A1-3	C2	C3	C4	D	A1-3 min	A1-3 max
HWD	kg	0,399	0	0	0	-0,225	0,354	0,452
NHWD	kg	1,88	0	0	8,39E-03	-1,05	1,68	2,02
RWD	kg	5,61E-03	0	0	0	-2,56E-03	4,82E-03	6,22E-03

OUTPUT FLOWS	UNIT	A1-3	C2	C3	C4	D	A1-3 min	A1-3 max
CRU	kg	1,22E-03	0	0	0	0	7,26E-04	1,80E-03
MFR	kg	0,236	0	0	0	0	0,139	0,301
MER	kg	1,39E-03	0	0	0	0	8,29E-04	2,06E-03
EE	MJ	1,48E-03	0	0	0	0	8,81E-04	2,19E-03

**RESOURCE USE.** PERE: Renewable primary energy as energy carrier; PERM: Renewable primary energy resource as material utilization; PERT: Total use of renewable primary energy resources; PENRE: Non-renewable primary energy as energy carrier; PENRM: Non-renewable primary energy as material utilization; PENRT: Total use of non-renewable primary energy resources; SM: Use of secondary materials; RSF: Use of renewable secondary fuels; NRSF: Use of non-renewable secondary fuels; FW: Use of net fresh water.

**WASTE CATEGORIES.** HWD: Hazardous waste disposed; NHWD: Non-hazardous waste disposed; RWD: Radioactive waste disposed.

**OUTPUT FLOWS.** CRU: Components for re-use; MFR: Materials for recycling; MER: Materials for energy recovery; EE: Exported energy per energy carrier.

## THERMAL BREAK ANODIZED ALUMINIUM PROFILE

BASIC ENVIRONMENTAL IMPACTS		UNIT	A1-3	C2	C3	C4	D	A1-3 min	A1-3 max
CC-2013	kg CO <sub>2</sub> eq	8,49	1,31E-02	1,07E-02	3,39E-03	-3,21	7,86	9,38	
CC-total	kg CO <sub>2</sub> eq	8,62	1,33E-02	1,14E-02	3,69E-03	-3,21	8,00	9,54	
CC-fossil	kg CO <sub>2</sub> eq	8,61	1,33E-02	1,13E-02	3,68E-03	-3,21	7,99	9,53	
CC-biogenic	kg CO <sub>2</sub> eq	4,28E-03	0	9,16E-06	7,52E-07	-7,65E-04	3,76E-03	4,80E-03	
CC-luluc	kg CO <sub>2</sub> eq	5,75E-03	0	4,18E-05	2,00E-07	-5,96E-04	4,66E-03	7,91E-03	
OD	kg CFC-11 eq	3,68E-07	2,04E-11	1,32E-09	7,72E-11	-2,42E-11	3,14E-07	4,70E-07	
A	mol H <sup>+</sup> eq	5,90E-02	8,89E-05	8,84E-05	6,31E-06	-1,88E-02	5,34E-02	6,34E-02	
EAF	kg PO <sub>4</sub> <sup>-3</sup> eq	3,77E-03	1,43E-05	1,39E-05	4,82E-05	0	3,36E-03	4,28E-03	
EAM	kg N eq	8,19E-03	4,20E-05	1,23E-05	6,39E-06	-2,72E-03	7,76E-03	8,72E-03	
ET	mol N eq	8,00E-02	4,60E-04	1,26E-04	2,53E-05	-2,97E-02	7,18E-02	8,55E-02	
POF	kg NMVOC eq	2,33E-02	1,17E-04	3,52E-05	6,98E-06	-8,17E-03	2,11E-02	2,53E-02	
AD-non fossil	kg Sb eq	1,10E-05	5,24E-10	7,59E-09	6,42E-10	-7,25E-07	1,00E-05	1,37E-05	
AD-fossil	MJ	122	0,186	0,213	1,38E-02	-39,6	114	140	
WU	m <sup>3</sup> eq	2,14	5,06E-05	3,28E-03	2,41E-03	-0,343	1,76	2,62	
ADDITIONAL ENVIRONMENTAL IMPACTS		UNIT	A1-3	C2	C3	C4	D	A1-3 min	A1-3 max
PM	Disease incidence	5,17E-07	7,68E-10	1,77E-10	4,84E-11	-2,62E-07	4,61E-07	5,59E-07	
IR	kBq U235 eq	1,17	3,24E-05	4,79E-03	4,18E-05	-0,451	1,01	1,30	
EF	CTUe	27,4	4,26E-04	7,69E-02	0,551	-0,143	24,6	30,3	
HT-c	CTUh	1,79E-07	6,89E-12	3,64E-10	2,25E-10	-5,18E-09	1,58E-07	2,44E-07	
HT-nc	CTUh	1,17E-06	4,17E-11	1,60E-09	5,76E-09	-1,33E-07	1,05E-06	1,25E-06	
LU	Dimensionless	32,6	0	8,30E-02	8,84E-03	-0,752	15,1	65,7	

**ENVIRONMENTAL IMPACTS.** **CC-2013:** Climatic Change according to EN 15804:2012+A1:2013; **CC-total:** Climatic Change - total; **CC-fossil:** Climatic Change - fossil; **CC-biogenic:** Climate change - biogenic; **CC-luluc:** Climate change - land use and land use change; **OD:** Ozone depletion; **A:** Acidification ; **EAF:** Eutrophication aquatic freshwater; **EAM:** Eutrophication aquatic marine; **ET:** Eutrophication terrestrial; **POF:** Photochemical ozone formation; **AD- non fossil:** Abiotic resource depletion - minerals and metals; **AD-fossil:** Abiotic resource depletion - fossils; **WU:** Water use; **PM:** Particulate matter emissions; **IR:** Ionising radiation; **EF:** Ecotoxicity - freshwater; **HT-c:** Human toxicity, cancer effects; **HT-nc:** Human toxicity, non-cancer effects; **LU:** Land use.

## THERMAL BREAK ANODIZED ALUMINIUM

RESOURCE USE	UNIT	A1-3	C2	C3	C4	D	A1-3 min	A1-3 max
PERE	MJ	30,4	0	0	0	-18,0	26,8	33,5
PERM	MJ	1,61E-04	0	0	0	0	9,64E-05	2,34E-04
PERT	MJ	30,4	0	0	0	-18,0	26,8	33,5
PENRE	MJ	71,7	0	0	0	-39,5	63,5	78,8
PENRM	MJ	4,02E-04	0	0	0	0	2,41E-04	5,86E-04
PENRT	MJ	71,7	0	0	0	-39,5	63,5	78,8
SM	kg	0,365	0	0	0	0,393	0,334	0,389
RSF	MJ	6,44E-04	0	0	0	0	3,85E-04	9,37E-04
NRSF	MJ	7,24E-04	0	0	0	0	4,34E-04	1,05E-03
FW	m <sup>3</sup> eq	0,563	0	0	0	-0,140	0,473	0,687
WASTE CATEGORIES	UNIT	A1-3	C2	C3	C4	D	A1-3 min	A1-3 max
HWD	kg	0,354	0	0	0	-0,208	0,310	0,390
NHWD	kg	1,94	0	0	6,00E-03	-0,97	1,48	2,12
RWD	kg	5,18E-03	0	0	0	-2,36E-03	4,27E-03	6,01E-03
OUTPUT FLOWS	UNIT	A1-3	C2	C3	C4	D	A1-3 min	A1-3 max
CRU	kg	1,13E-03	0	0	0	0	6,74E-04	1,64E-03
MFR	kg	0,218	0	0	0	0	0,134	0,299
MER	kg	1,29E-03	0	0	0	0	7,71E-04	1,87E-03
EE	MJ	1,37E-03	0	0	0	0	8,19E-04	1,99E-03

**RESOURCE USE.** PERE: Renewable primary energy as energy carrier; PERM: Renewable primary energy resource as material utilization; PERT: Total use of renewable primary energy resources; PENRE: Non-renewable primary energy as energy carrier; PENRM: Non-renewable primary energy as material utilization; PENRT: Total use of non-renewable primary energy resources; SM: Use of secondary materials; RSF: Use of renewable secondary fuels; NRSF: Use of non-renewable secondary fuels; FW: Use of net fresh water.

**WASTE CATEGORIES.** HWD: Hazardous waste disposed; NHWD: Non-hazardous waste disposed; RWD: Radioactive waste disposed.

**OUTPUT FLOWS.** CRU: Components for re-use; MFR: Materials for recycling; MER: Materials for energy recovery; EE: Exported energy per energy carrier.

## THERMAL BREAK COATED ALUMINIUM PROFILE

BASIC ENVIRONMENTAL IMPACTS		UNIT	A1-3	C2	C3	C4	D	A1-3 min	A1-3 max
CC-2013	kg CO <sub>2</sub> eq	7,80	1,31E-02	1,07E-02	4,39E-03	-3,08	7,25	8,69	
CC-total	kg CO <sub>2</sub> eq	7,91	1,33E-02	1,14E-02	4,76E-03	-3,08	7,35	8,83	
CC-fossil	kg CO <sub>2</sub> eq	7,91	1,33E-02	1,13E-02	4,76E-03	-3,08	7,34	8,82	
CC-biogenic	kg CO <sub>2</sub> eq	3,63E-03	0	9,16E-06	1,05E-06	-7,34E-04	3,30E-03	4,19E-03	
CC-luluc	kg CO <sub>2</sub> eq	5,75E-03	0	4,18E-05	2,80E-07	-5,72E-04	5,00E-03	8,02E-03	
OD	kg CFC-11 eq	2,17E-07	2,04E-11	1,32E-09	1,03E-10	-2,32E-11	1,78E-07	4,05E-07	
A	mol H <sup>+</sup> eq	4,45E-02	8,89E-05	8,84E-05	7,09E-06	-1,80E-02	4,08E-02	4,84E-02	
EAF	kg PO <sub>4</sub> <sup>-3</sup> eq	2,56E-03	1,43E-05	1,39E-05	5,93E-05	0	2,32E-03	3,17E-03	
EAM	kg N eq	7,47E-03	4,20E-05	1,23E-05	7,86E-06	-2,61E-03	6,96E-03	7,97E-03	
ET	mol N eq	7,26E-02	4,60E-04	1,26E-04	2,80E-05	-2,84E-02	6,60E-02	7,76E-02	
POF	kg NMVOC eq	2,12E-02	1,17E-04	3,52E-05	7,78E-06	-7,84E-03	1,95E-02	2,31E-02	
AD-non fossil	kg Sb eq	5,06E-06	5,24E-10	7,59E-09	8,81E-10	-6,95E-07	4,50E-06	7,95E-06	
AD-fossil	MJ	110	0,186	0,213	1,53E-02	-38,0	103	128	
WU	m <sup>3</sup> eq	2,08	5,06E-05	3,28E-03	3,37E-03	-0,329	1,85	2,57	
ADDITIONAL ENVIRONMENTAL IMPACTS		UNIT	A1-3	C2	C3	C4	D	A1-3 min	A1-3 max
PM	Disease incidence	4,84E-07	7,68E-10	1,77E-10	5,83E-11	-2,52E-07	4,31E-07	5,26E-07	
IR	kBq U235 eq	0,93	3,24E-05	4,79E-03	5,08E-05	-0,433	0,83	1,06	
EF	CTUe	12,0	4,26E-04	7,69E-02	0,767	-0,137	10,6	15,8	
HT-c	CTUh	1,65E-07	6,89E-12	3,64E-10	2,46E-10	-4,97E-09	1,38E-07	2,38E-07	
HT-nc	CTUh	4,81E-07	4,17E-11	1,60E-09	8,00E-09	-1,28E-07	4,16E-07	5,74E-07	
LU	Dimensionless	29,6	0	8,30E-02	1,24E-02	-0,722	11,5	63,2	

**ENVIRONMENTAL IMPACTS.** **CC-2013:** Climatic Change according to EN 15804:2012+A1:2013; **CC-total:** Climatic Change - total; **CC-fossil:** Climatic Change - fossil; **CC-biogenic:** Climate change - biogenic; **CC-luluc:** Climate change - land use and land use change; **OD:** Ozone depletion; **A:** Acidification ; **EAF:** Eutrophication aquatic freshwater; **EAM:** Eutrophication aquatic marine; **ET:** Eutrophication terrestrial; **POF:** Photochemical ozone formation; **AD- non fossil:** Abiotic resource depletion - minerals and metals; **AD-fossil:** Abiotic resource depletion - fossils; **WU:** Water use; **PM:** Particulate matter emissions; **IR:** Ionising radiation; **EF:** Ecotoxicity - freshwater; **HT-c:** Human toxicity, cancer effects; **HT-nc:** Human toxicity, non-cancer effects; **LU:** Land use.

## THERMAL BREAK COATED ALUMINIUM PROFILE

RESOURCE USE	UNIT	A1-3	C2	C3	C4	D	A1-3 min	A1-3 max
PERE	MJ	29,2	0	0	0	-17,2	25,6	32,1
PERM	MJ	1,54E-04	0	0	0	0	9,19E-05	2,28E-04
PERT	MJ	29,2	0	0	0	-17,2	25,6	32,1
PENRE	MJ	68,8	0	0	0	-37,9	60,5	75,4
PENRM	MJ	3,86E-04	0	0	0	0	2,30E-04	5,70E-04
PENRT	MJ	68,8	0	0	0	-37,9	60,5	75,4
SM	kg	0,350	0	0	0	0,377	0,318	0,373
RSF	MJ	6,17E-04	0	0	0	0	3,68E-04	9,13E-04
NRSF	MJ	6,95E-04	0	0	0	0	4,14E-04	1,03E-03
FW	m <sup>3</sup> eq	0,550	0	0	0	-0,135	0,460	0,677
WASTE CATEGORIES	UNIT	A1-3	C2	C3	C4	D	A1-3 min	A1-3 max
HWD	kg	0,353	0	0	0	-0,200	0,307	0,401
NHWD	kg	1,66	0	0	8,39E-03	-0,93	1,38	1,89
RWD	kg	4,97E-03	0	0	0	-2,26E-03	4,07E-03	5,75E-03
OUTPUT FLOWS	UNIT	A1-3	C2	C3	C4	D	A1-3 min	A1-3 max
CRU	kg	1,08E-03	0	0	0	0	6,43E-04	1,60E-03
MFR	kg	0,215	0	0	0	0	0,125	0,296
MER	kg	1,23E-03	0	0	0	0	7,35E-04	1,83E-03
EE	MJ	1,31E-03	0	0	0	0	7,81E-04	1,94E-03

**RESOURCE USE.** PERE: Renewable primary energy as energy carrier; PERM: Renewable primary energy resource as material utilization; PERT: Total use of renewable primary energy resources; PENRE: Non-renewable primary energy as energy carrier; PENRM: Non-renewable primary energy as material utilization; PENRT: Total use of non-renewable primary energy resources; SM: Use of secondary materials; RSF: Use of renewable secondary fuels; NRSF: Use of non-renewable secondary fuels; FW: Use of net fresh water.

**WASTE CATEGORIES.** HWD: Hazardous waste disposed; NHWD: Non-hazardous waste disposed; RWD: Radioactive waste disposed.

**OUTPUT FLOWS.** CRU: Components for re-use; MFR: Materials for recycling; MER: Materials for energy recovery; EE: Exported energy per energy carrier.

# SUPPLEMENT INFORMATION

## ANODIZED ALUMINIUM PROFILE

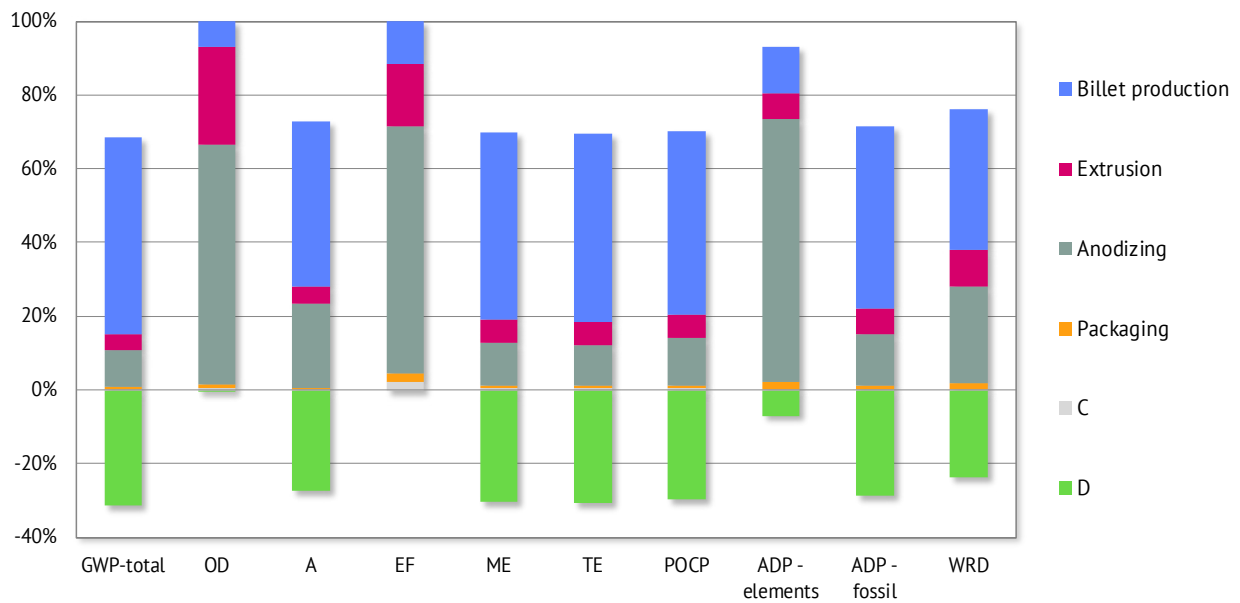

## COATED ALUMINIUM PROFILE

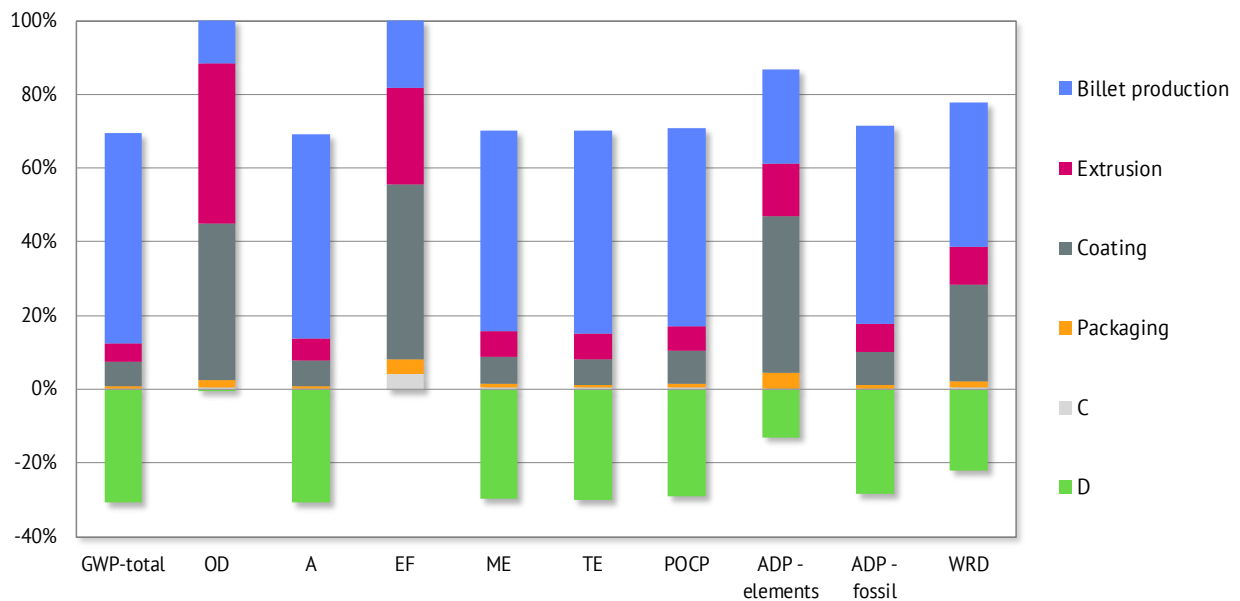

## THERMAL BREAK ANODIZED ALUMINIUM PROFILE

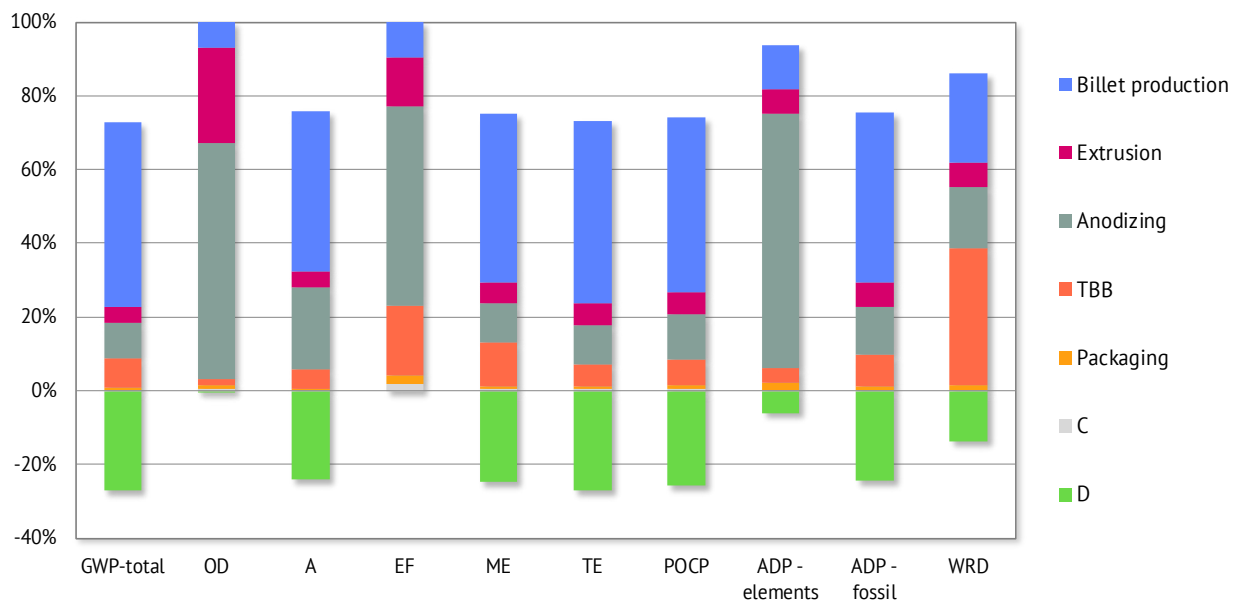

## THERMAL BREAK COATED ALUMINIUM PROFILE

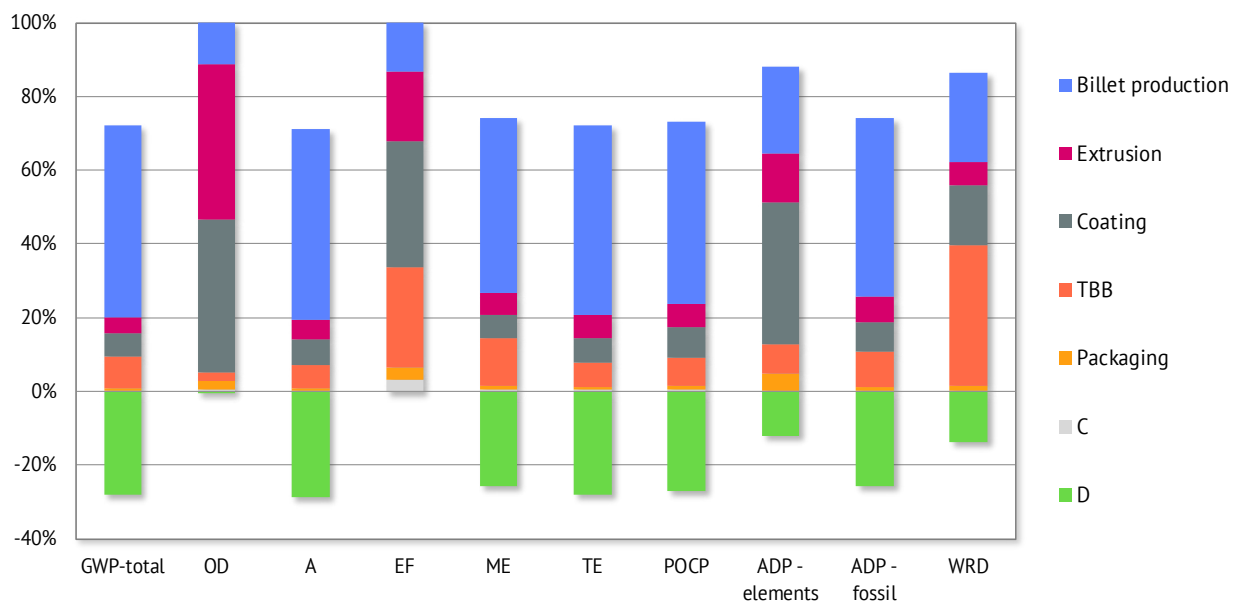

TBB inclusion, either in anodized or coated profile, does not affect the overall result in relation to the coated and anodized profiles. The TBB presence replaces part of the aluminium in profile. Not only less starting aluminium is used (as raw material) but also it is necessary to extrude less amount of profile, or anodize or coat less aluminium surface. This explains the slight decrease in some impacts categories of thermal break aluminium profiles in relation to the coated and anodized profiles.

It is also noteworthy that the presence of plastic components in the profile (powder coating and/ or TBB) reduces the useful amount of aluminium to be recycled at the end of life (the avoided impacts are reduced - module D-) and it supposes a greater problem in the landfill (increasing impacts reported in C4). However, module D is in all cases a very significant reduction in all indicators due to the replacement of primary aluminium.



# VERIFICATION

This declaration is an environmental product declaration (EPD) in accordance with ISO 14025 and the requirements given in the product category rules document for Construction Products and Construction Services (EN 15804) and the general program guidelines by The International EPD® System. The results shown in this EPD are based on the LCA report for sector EPD of the Spanish Association of Aluminium of April 12, 2020 according to standard 14044.

This EPD is not comparative assertions and are either not comparable or have limited comparability when they cover different life cycle stages or are based on different Product Category Rules. EPDs of construction products may not be comparable if they do not comply with EN 15804. This DAP is not representative of any particular manufacturer or any of its products; on the other hand, it is the average of the products manufactured by the members of the AEA.

The EPD owner is responsible for its content, as well as to preserve supporting documentation during the period of validity that justifies the data and statements that are included.

<b>EPD Programme</b>	The International EPD® System EPD International AB Box 210 60 SE-100 31 Stockholm Sweden www.environdec.com info@environdec.com
<b>EPD registration number</b>	S-P-01409
<b>EPD owner</b>	Asociación Española del Aluminio y Tratamientos de Superficie
<b>Declared unit</b>	1 kg of coated aluminium profile, anodized aluminium profile, thermal break coated aluminium profile and thermal break anodized aluminium profile
<b>System boundaries</b>	Cradle to gate with options
<b>Published</b>	2018 - 10 - 31
<b>Revision date</b>	2020 - 04 - 27
<b>Valid until</b>	2025 - 04 - 27
<b>Reference year for data</b>	2017
<b>Geographical scope</b>	Worldwide
<b>Product group classification</b>	UN CPC Code: 41532 Bars, rods and profiles, of aluminium
<b>Product Category Rules</b>	PCR 2019:14 v1.0 Construction products and Construction services. Based on CEN standard 15804:2012+A2:2019
<b>PCR review was conducted by</b>	Technical Committee of The International EPD® System
<b>Independent verification of the declaration and data, according to ISO 14025:2006</b>	<input checked="" type="checkbox"/> External <input type="checkbox"/> Internal <input type="checkbox"/> EPD®
<b>Third-party verifier</b>	Eva Martínez Herrero Centro Tecnológico de Miranda de Ebro www.ctme.es
<b>EPD prepared by</b>	IDNÓVAM Innovación y desarrollo para el ambiente info@idnovam.com

# REFERENCES

- General Programme Instructions of The International EPD® System. Version 3.01, 2019-09-18.
- Product Category Rules 2019:14 v1.0. Construction products. EPD System. Date 2019-12-20. Valid until 2024-12-20.
- EN 15804:2012+A2:2019, Sustainability of construction works - Environmental Product Declarations - Core rules for the product category of construction products
- ISO 14025/ DIN EN ISO 14025:2009-11: Environmental labels and declarations - Type III environmental
- ISO 14040-44/ DIN EN ISO 14040:2006-10, Environmental management - Life cycle assessment-Principles
- European Life Cycle Database. ELCD 3.3. <http://eplca.jrc.ec.europa.eu/ELCD3/index.xhtml?stock=default>
- Ecoinvent Database. <http://www.ecoinvent.org/database/>.
- Life-Cycle inventory data for aluminium production and transformation processes in Europe. Environmental Profile Report. February 2018.
- K. Peeters, C. Spirinckx, LOT 32 / Ecodesign of Window Products Task 2-Market Analysis, 2015.
- Tackling recycling aspects in EN15804 - Christian Leroy, Jean-Sebastien Thomas, Nick Avery, Jan Bollen, and Ladji Tikana. International Symposium on Life Cycle Assessment and Construction, 2012.
- Aluminium Recycling in LCA – European Aluminium Association, 2013.
- UNE-EN 16449:2014. Madera y productos derivados de a madera. Cálculo del contenido en carbono biogénico de la madera y conversión en dióxido de carbono.

# CONTACTS

## EPD PROGRAMME



### The International EPD® System

EPD International AB  
Box 210 60  
SE-100 31 Stockholm  
Sweden  
[www.environdec.com](http://www.environdec.com)

## THIRD-PARTY VERIFIER



### Eva Martínez Herrero

Centro Tecnológico de Miranda de Ebro  
[www.ctme.es](http://www.ctme.es)  
[evamtz@ctme.es](mailto:evamtz@ctme.es)

## EPD OWNER



### Asociación Española del Aluminio y Tratamientos de Superficie

Príncipe de Vergara, 74  
28006 Madrid  
[www.asoc-aluminio.es](http://www.asoc-aluminio.es)  
[aea@asoc-aluminio.es](mailto:aea@asoc-aluminio.es)

## EPD AUTHOR



### IDNÓVAM

Innovación y desarrollo para el ambiente  
Veneras 9, planta 6  
28013 Madrid  
[info@idnovam.com](mailto:info@idnovam.com)

The logo consists of the letters 'AEA' in a bold, blue, sans-serif font. The letters are closely spaced and have a slight shadow effect, giving them a three-dimensional appearance.

**AEA**

**Asociación Española del Aluminio  
y Tratamientos de Superficie**

[www.asoc-aluminio.es](http://www.asoc-aluminio.es)